

Technical Review

To Advance Techniques in Acoustical, Electrical, and Mechanical Measurement

Use of Warble Tone and Narrow Band Random Noise

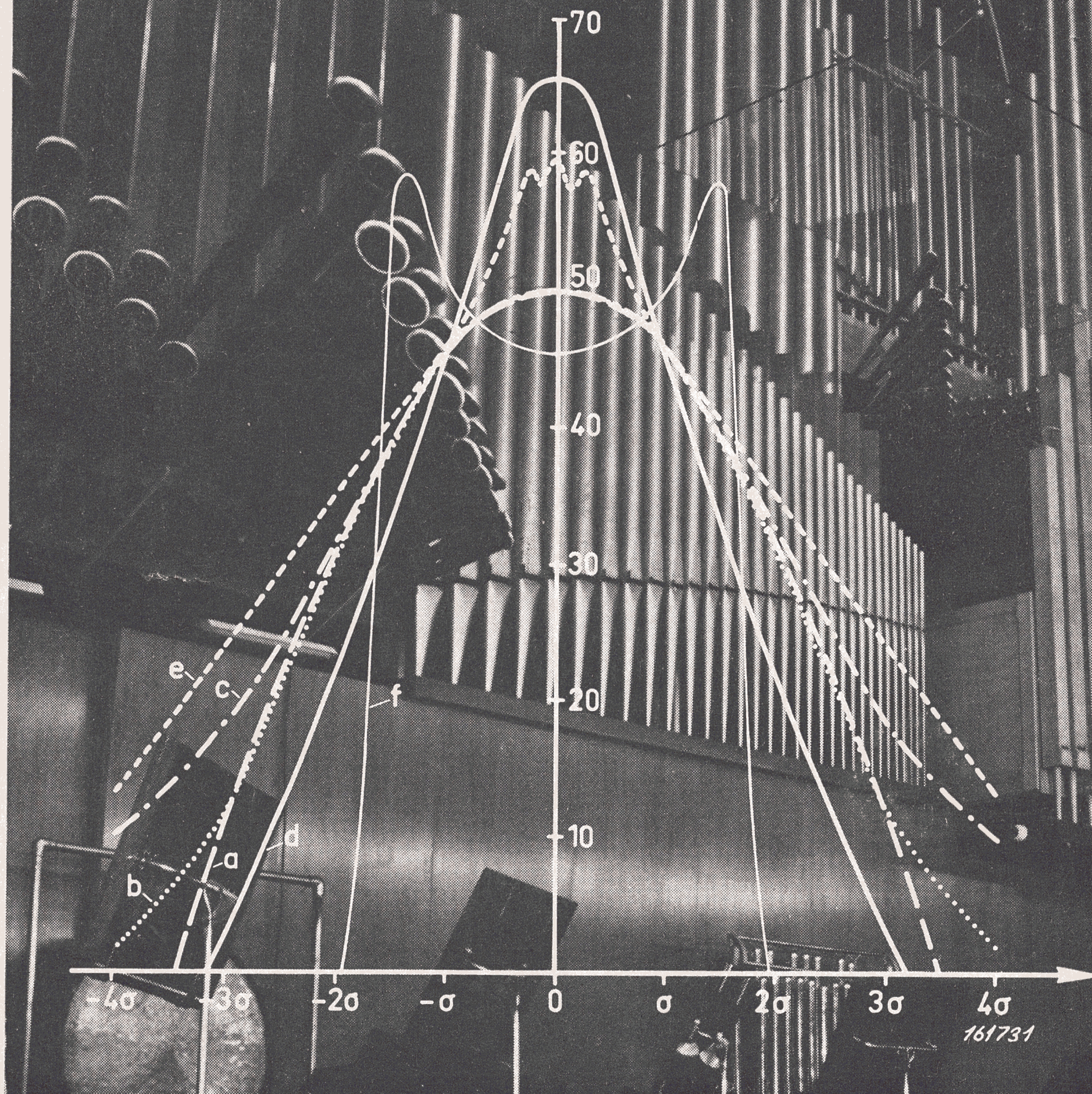

**PREVIOUSLY ISSUED NUMBERS OF
BRÜEL & KJÆR TECHNICAL REVIEW**

- 1-1956 Noise Measurements and Analyses.
- 2-1956 Use of Resistance Strain Gauges to determine Friction Coefficients.
- 3-1956 Determination of Acoustical Quality of Rooms from Reverberation Curves.
- 4-1956 Electrical Measurements of Mechanical Vibrations.
- 1-1957 Strain Gauge Measurements.
- 2-1957 Sound Analysis in Industrial Processes and Production.
- 3-1957 Measurement on Tape Recorders.
- 4-1957 Measurements of Modules of Elasticity and Loss Factor for Solid Materials.
Surface Roughness Measurements.
- 1-1958 Measurement of the Complex Modulus of Elasticity.
- 2-1958 Vibration Testing of Components.
Automatic Level Regulation of Vibration Exciters.
- 3-1958 Design Features in Microphone Amplifier Type 2603 and A. F. Spectrometer Type 2110.
A true RMS Instrument.
- 4-1958 Microphonics in Vacuum Tubes.
- 1-1959 A New Condenser Microphone.
Free Field Response of Condenser Microphones.
- 2-1959 Free Field Response of Condenser Microphones (Part II)
- 3-1959 Frequency-Amplitude Analyses of Dynamic Strain and its Use in Modern Measuring Technique.
- 4-1959 Automatic Recording of Amplitude Density Curves.
- 1-1960 Pressure Equalization of Condenser Microphones and Performance at Varying Altitudes.
- 2-1960 Aerodynamically Induced Noise of Microphones and Windscreens.
- 3-1960 Vibration Exciter Characteristics.
- 4-1960 R.M.S. Recording of Narrow Band Noise with the Level Recorder Type 2305.
- 1-1961 Effective Averaging Time of the Level Recorder Type 2305.
- 2-1961 The Application and Generation of Audio Frequency Random Noise.
- 3-1961 On the Standardisation of Surface Roughness
- 4-1961 Artificial Ears.
- 1-1962 Artificial Ears part 2.
- 2-1962* Loudness Evaluation.
- 3-1962* Stereophonic Gliding Frequency Records.

* Also published in French.

TECHNICAL REVIEW

No. 4 - 1962

On the Use of Warble Tone and Random Noise for Acoustic Measurement Purposes

By *Jens T. Broch*, Dipl. Ing. E.T.H.*)

ABSTRACT

The requirements that an acoustic test signal should fulfill are briefly outlined. It is found that in cases where time and space averaging are necessary to obtain realistic measuring results, either bands of random noise or warbled tones should be used. The physical properties of the two types of complex test signals are discussed with respect to the frequency- and time-distribution of the energy. The importance of using random noise where non-linearities are present in the test system is pointed out, and an example shown. It is concluded that bands of random noise will be the most desirable complex test signal to use, while in many cases this type of signal may, for economical reasons, be substituted by warbled tones.

SOMMAIRE

L'examen des caractéristiques à exiger d'un signal d'essais acoustiques montre que dans les cas où une intégration dans le temps ou dans l'espace est mise en jeu, il est nécessaire d'employer soit une bande de bruit blanc soit un signal modulé en fréquence (hululeur). Les propriétés énergétiques de ces signaux sont comparées au point de vue de la répartition en fréquence et statistique. La nécessité d'employer le bruit blanc lorsque le système en essais présente des non-linéarités est démontrée et illustrée par un exemple. L'étude permet de conclure en général à la supériorité du bruit blanc en remarquant toutefois que dans de nombreux cas le signal modulé, plus facile à obtenir, peut lui être substitué.

ZUSAMMENFASSUNG

Als Prüfsignale für raumakustische Messungen verwendet man im allgemeinen entweder gefiltertes Rauschen oder Heultöne. Die Eigenschaften dieser beiden Signalarten werden anhand der Frequenz- und Zeitverteilung ihrer Energie diskutiert. Es zeigt sich, daß gefiltertes Rauschen die besseren zeitlichen und räumlichen Mittelwerte liefert, besonders, wenn Nichtlinearitäten im Prüfsystem vorhanden sind. Heultöne, die mit einem geringeren Aufwand erzeugt werden können, liefern jedoch ebenfalls brauchbare Ergebnisse.

The word "ACOUSTIC" is derived from greek and is commonly used to designate the physical behaviour of sound waves. To further specify particular aspects of acoustics, terms are often used like "electro-acoustics", "room acoustics" (architectural acoustics), "psycho-acoustics" and "noise control".

The study of each of these branches of acoustics requires a somewhat different measurement technique, and so the requirements for the signal source will also vary.

As long as the exact behaviour of, for example, electro-mechanical- acoustical transducers is investigated, the most convenient signal to use is the simple, pure sine-wave. However, most phenomena related to room- and psycho-

* Paper given at the 4th International Congress on Acoustics, Copenhagen 21-28 August 1962.

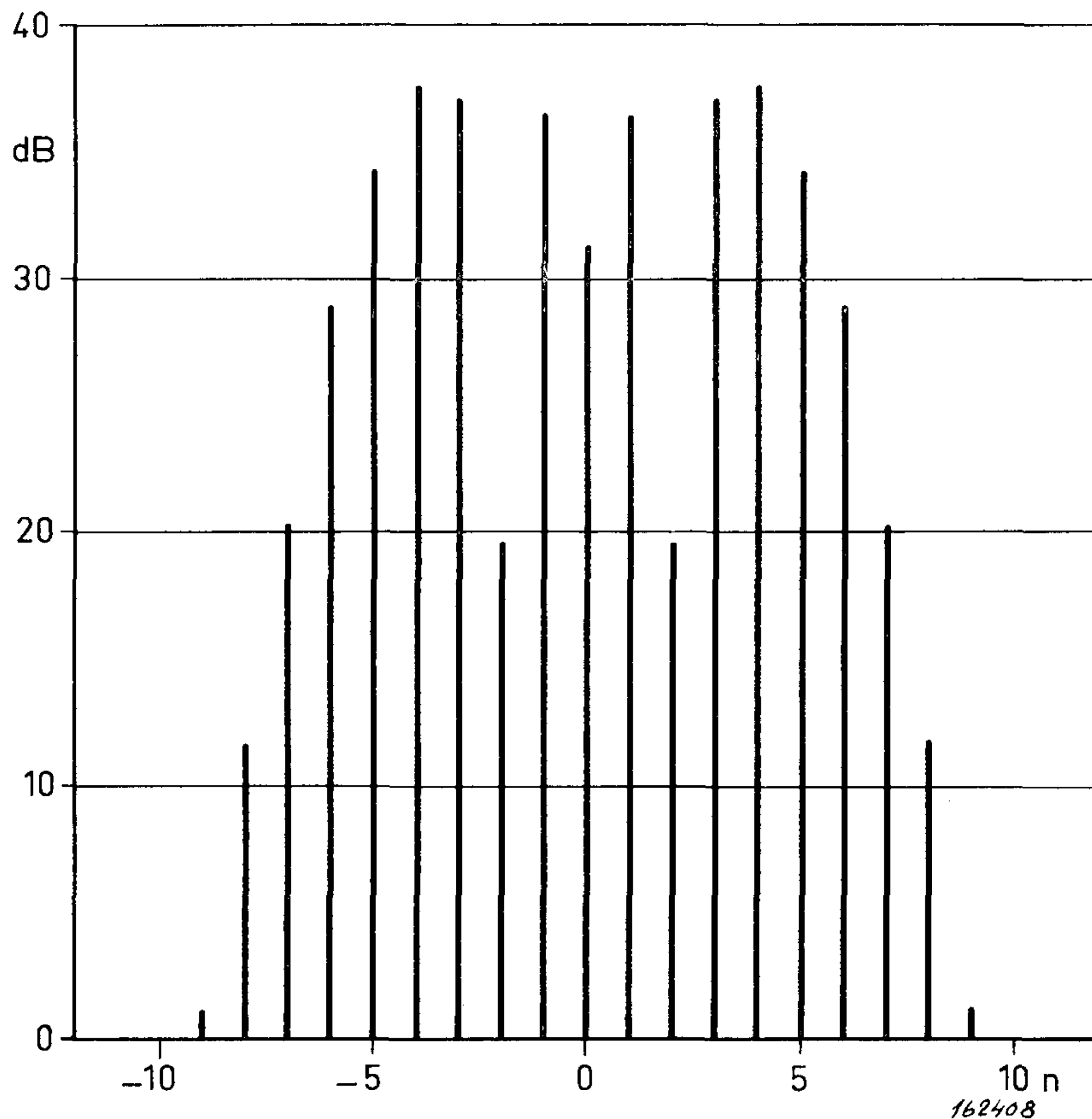

Fig. 1. Typical power spectrum of a frequency modulated signal. The modulating signal consists in this case of a pure sine wave. Modulation index 5.

an angular carrier frequency ω and a number of sidebands $\omega \pm n \times \Omega$, see Fig. 1. In acoustics one will normally be interested in producing a spectrum around the “carrier” frequency which is as flat as possible, e.g. each of the sidebands should contain the same amount of energy. To obtain this kind of spectrum the modulating signal should in fact not be a pure sine wave, but preferably a more complex wave. The ideal wave form one would expect to be triangular because then an equal amount of time is spent in equal frequency intervals around the carrier. However, not only the wave form of the modulating signal but also the modulation index changes the spectrum of the warble tone, so that “optimum” conditions depend on several factors.

For a long time the well known saw-tooth signal, Fig. 2, which is very easy to produce in practice, has been used as modulating signal. Saw-tooth modulation has been treated theoretically by Prof. J. Rybner of the Danish Technical University who was able to solve the problem by means of Fresnel integrals and integrals studied by E. Lommel. In his paper Prof. Rybner gives an example of the theoretical spectrum for a saw-tooth warble signal with a modulation index 5. (Fig. 3).

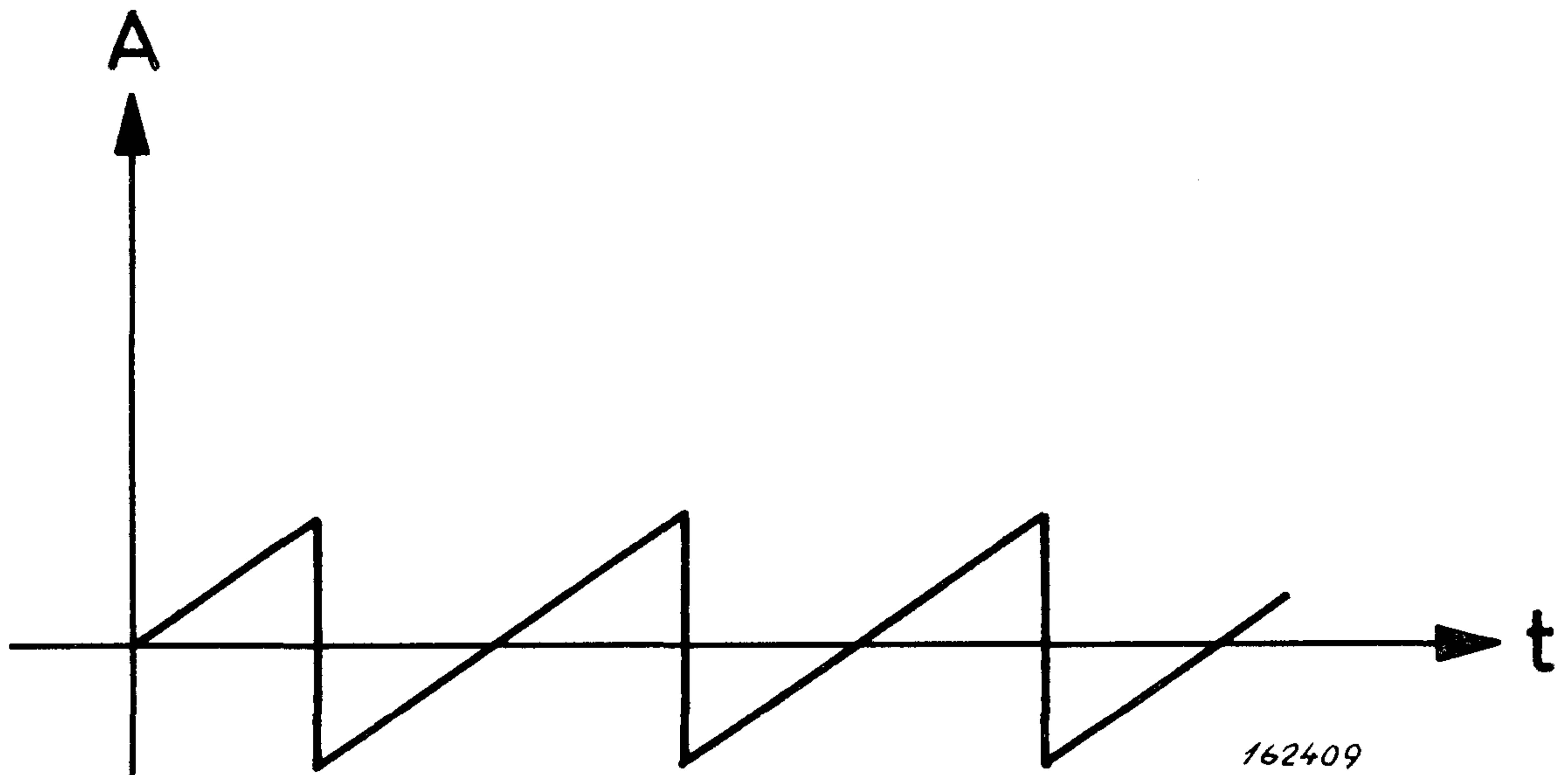

Fig. 2. Example of a saw-tooth type signal.

Investigations made at Brüel & Kjær indicate that a saw-tooth type signal is as well suited as a triangular wave for the modulation, and that to obtain an "optimum" spectrum shape, modulation indices of 10 or higher should be used. That the spectrum shape of a triangular modulation should not deviate too much from that of a saw-tooth is also to be expected on the basis of the amplitude density curves for the two types of signal, see Fig. 4.

From the spectra shown in Figs. 1, 3, and 4 it can be seen that whichever type of periodic modulating signal and value of modulation index are used

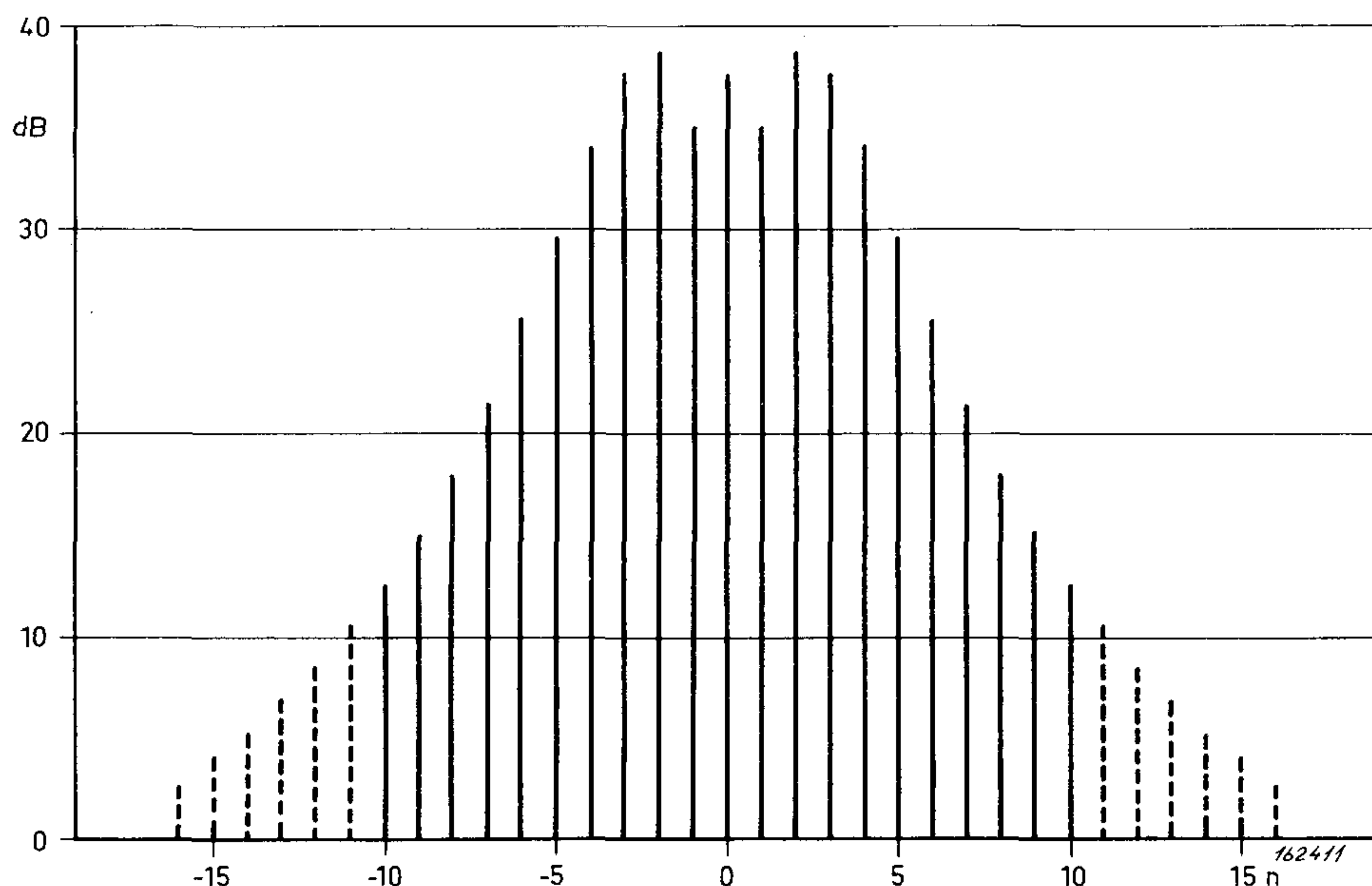

Fig. 3. Theoretical spectrum of a signal which is frequency modulated by means of a saw-tooth signal (Rybner).

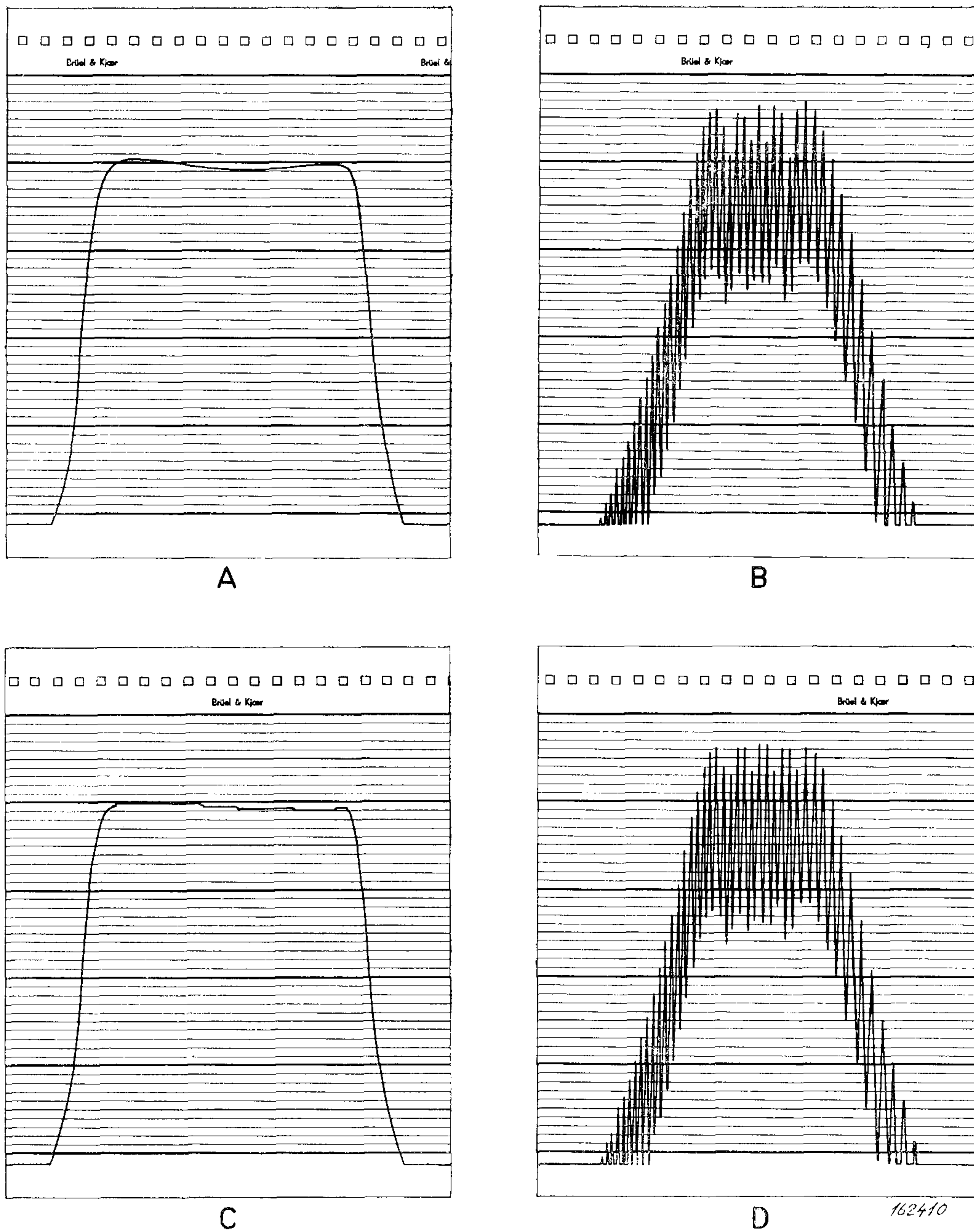

Fig. 4. Amplitude density curves of triangular and saw-tooth waves, together with modulation spectra obtained with the two types of signal. (The spectra were measured on a B & K Type 1014 oscillator).

- a) The amplitude density curve of a triangular wave.
- b) The modulation spectrum produced by warbling with a triangular signal. Modulation index approximately 10.
- c) The amplitude density curve of a saw-tooth type signal.
- d) The modulation spectrum produced by saw-tooth warbling. Modulation index approximately 10.

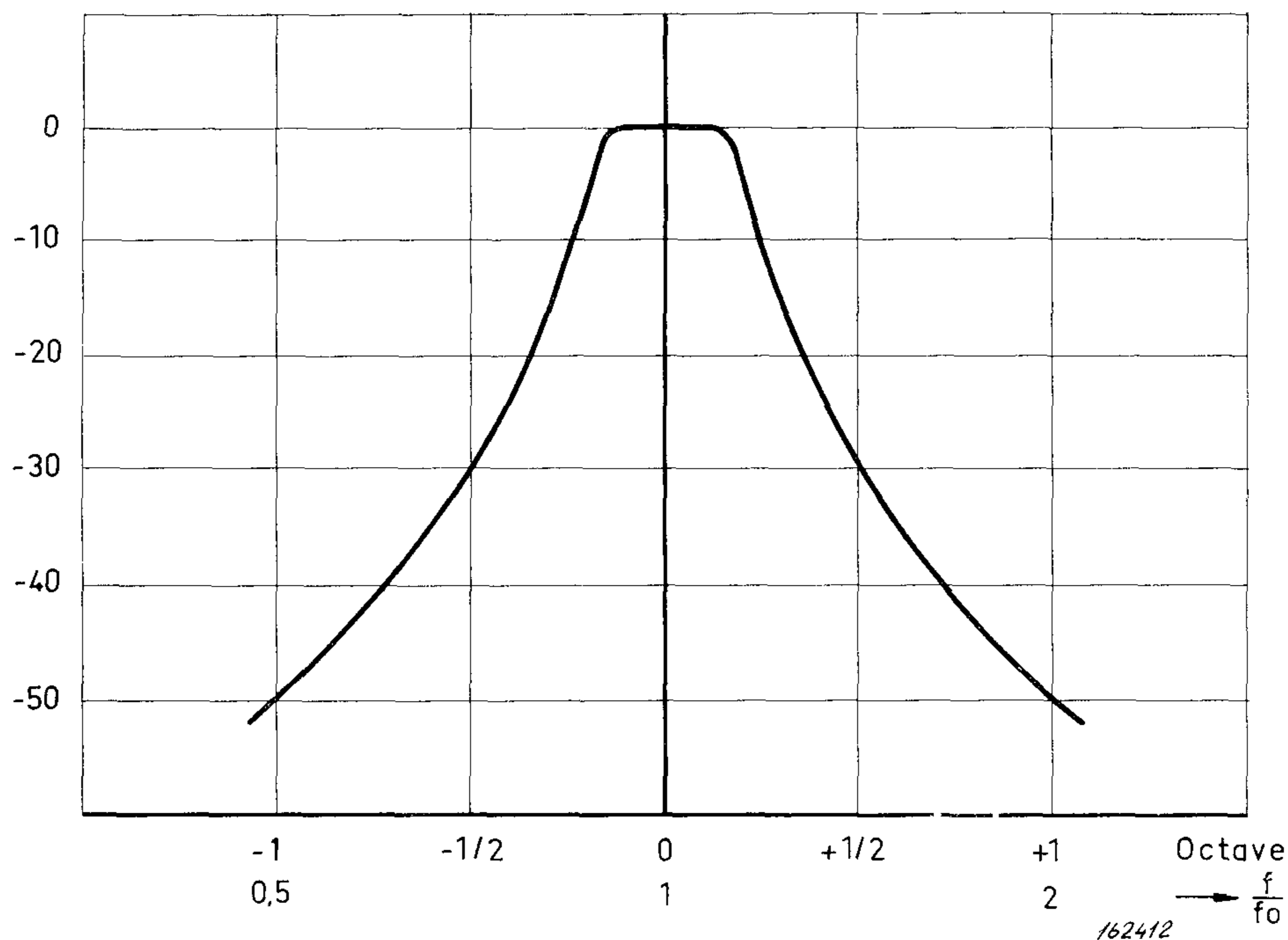

Fig. 5. The frequency spectrum of a band of noise.

to produce a warbled tone, the spectrum will consist of discrete lines spaced at multiples of the fundamental modulation frequency around the carrier. If, on the other hand, bands of random noise are used as test signal no discrete lines are obtained, the spectrum in this case being completely continuous within the band considered. Fig. 5 shows the spectrum of such a signal obtained by filtering white random noise through a 1/3 octave filter.

So far only the spectrum characteristics of the two types of signal have been discussed. However, also another significant difference exists, namely the amplitude vs. time relationship.

Fig. 6 shows a time record of a warbled signal, and Fig. 7 the same for a band of random noise photographed off the screen of a cathode ray oscilloscope. The bandwidths in both cases were the same. (By bandwidth

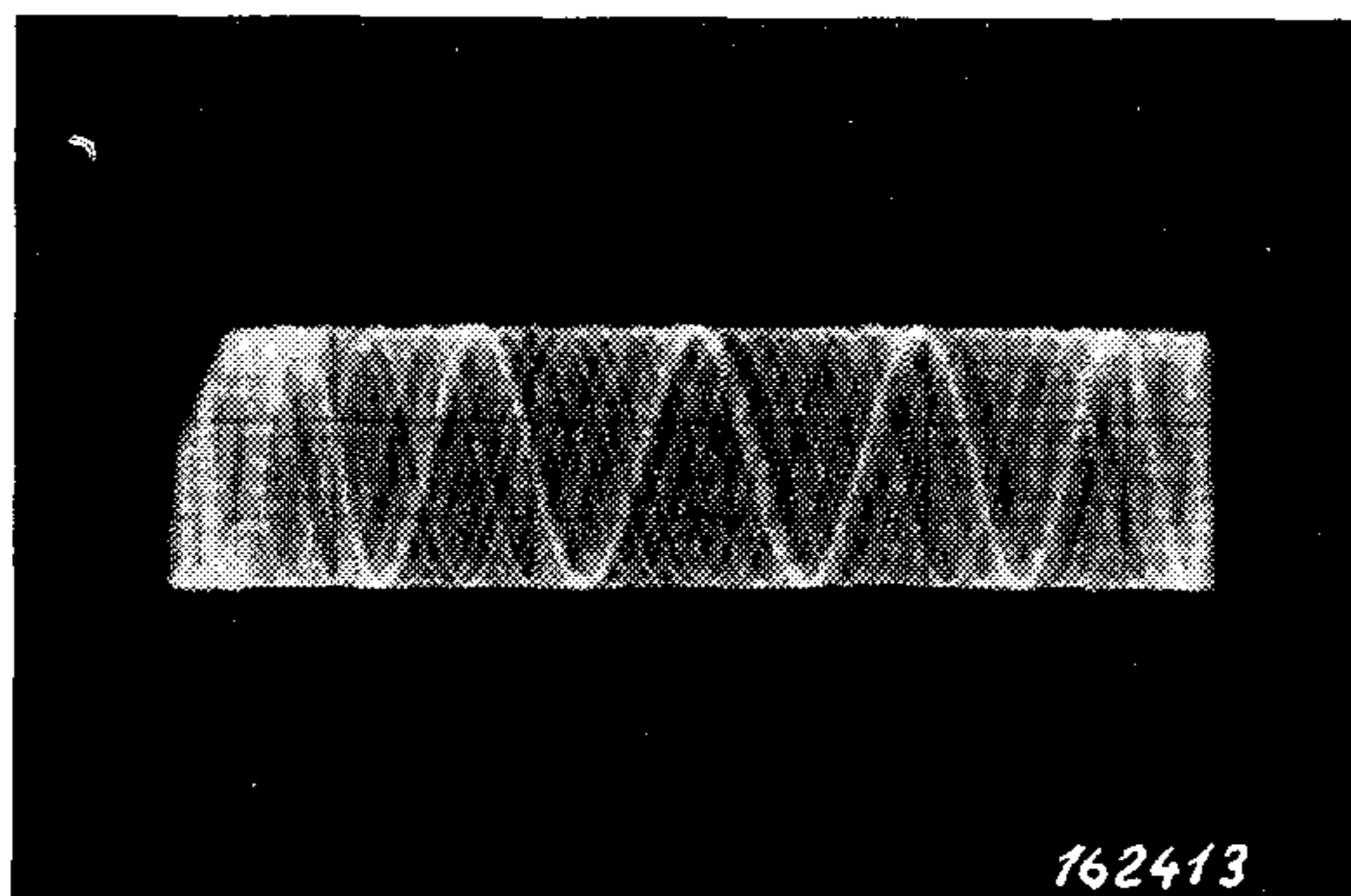

Fig. 6. Time record of a warbled signal.

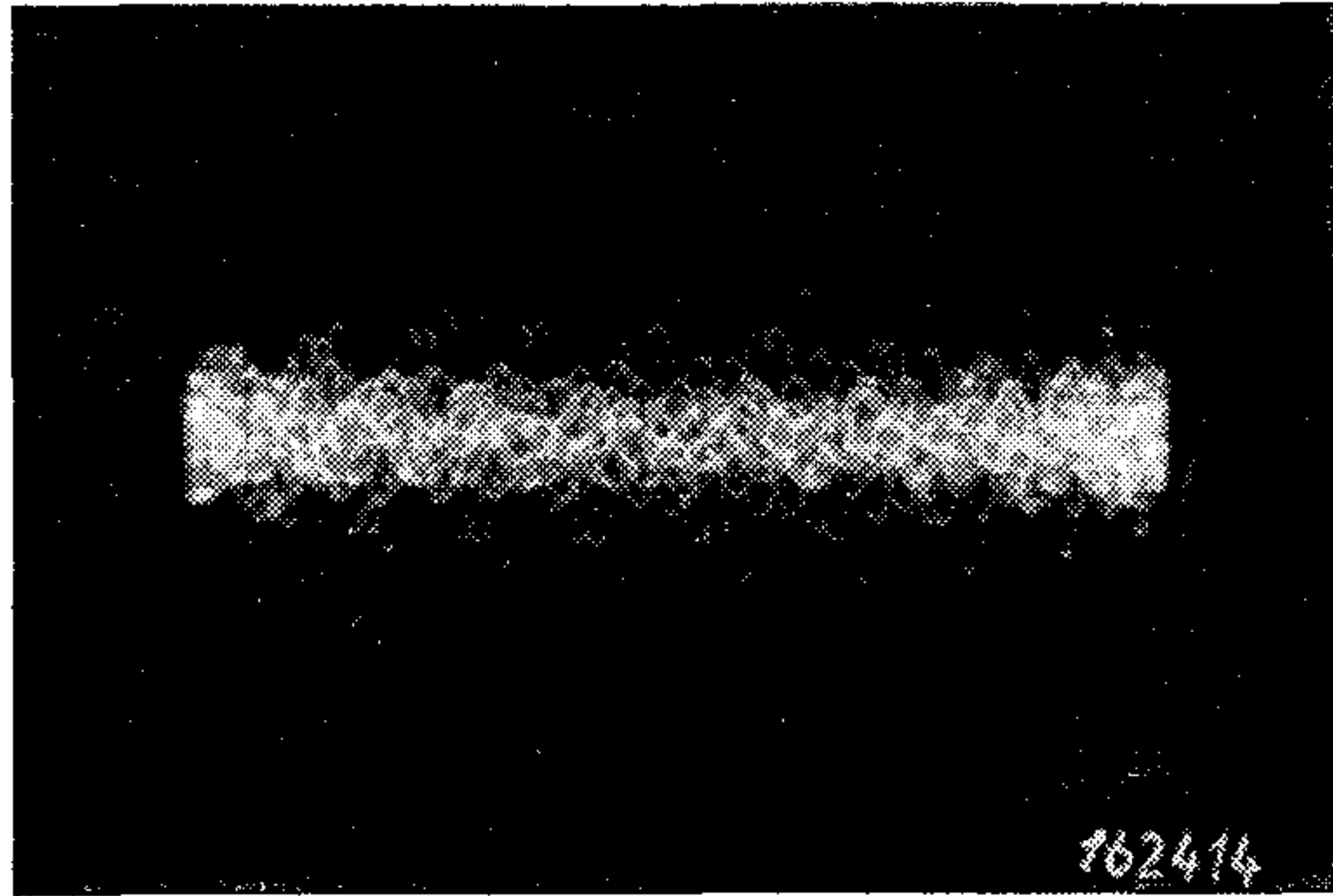

Fig. 7. Time record of a band of random noise.

is here meant the frequency band between the 3 db cut-off points of the signal frequency spectrum). It can be seen from the figure that while the maximum amplitude remains fairly constant for the warbled signal, it varies considerably with time for the noise band. This may, in some cases, influence the choice of averaging time in the measuring equipment.

Regarding the use of the two types of signal it must be viewed in relation to the actual measurement problems. In most room acoustic measurements one of the main difficulties is to obtain a realistic space averaging. It is well known to acoustical engineers, and can be shown theoretically by solving the proper wave equation, that sound energy emitted in a room builds up a set of standing waves. These are commonly classified as room resonances and form a rather complicated scheme of sound distribution vs. space coordinates at medium and higher frequencies. To investigate the usefulness of warbled signals relative to bands of noise when applied to room acoustic problems, M. I. Karnovski (U.S.S.R.) has studied the auto-correlation function for the two types of signal in the presence of a reflecting surface and assumed that, if the correlation coefficient $R(\tau)$ is less than 0.1, a practically diffuse sound field exists. He found the following expressions for the auto-correlation:

For "ideal" bands of random noise:

$$R_n(\tau) = \frac{\sin\left(\frac{\Delta\omega\tau}{2}\right)}{\Delta\omega\tau} \times \cos \omega_0\tau \quad (2)$$

For an "ideal" warbled signal:

$$R_w(\tau) = \frac{\sin\left(\frac{\Delta\omega\tau}{2}\right)}{n \sin\left(\frac{\Delta\omega\tau}{2n}\right)} \times \cos \omega_0\tau \quad (3)$$

where $\omega_0 = 2\pi f_0 =$ angular center frequency of the band considered, $\Delta\omega =$ bandwidth, $\tau =$ time difference between the direct and the reflected signal at the point of measurement and $n = 2m$ ($m =$ modulation index of the warbled

signal). It can be seen from (2) and (3) that if $n \rightarrow \infty$ then $R_n = R_w$, which means that for high modulation indices (m) of the warbled signal the interference picture for a band of random noise and a warbled signal of the same bandwidth and center frequency will be the same. The factor

$$E(n) = \frac{\sin\left(\frac{\Delta\omega\tau}{2}\right)}{n \sin\left(\frac{\Delta\omega\tau}{2n}\right)}$$

is plotted in Fig. 8 for various values of n .

From the figure it can be seen that in all circumstances, i.e. whether a warbled tone or a noise band is used as test signal a distinct interference picture will be obtained near the reflecting surface. However, in the case of warbled tones there is also a second strong interference range with a

maximum determined by the relation $\frac{\Delta\omega\tau}{2} = n \times \pi$. If τ is set equal to $2 \frac{l}{c}$ where l is the distance from the surface and c is the velocity of sound, the second interference maximum will occur at

$$l = \frac{n \times c}{2 \Delta f} = \frac{m \times c}{\Delta f}$$

where m is the modulation index of the warbled signal. for a modulation index of 10 ($n = 20$, see also Fig. 8) and a bandwidth $\Delta f = 350$ c/s, this second interference maximum will thus occur at a distance of about 10 m from the reflecting surface. For higher modulation indices the distance will be still greater and it may thus be assumed that when modulation indices of 10 or higher are used there will be very little difference in practice

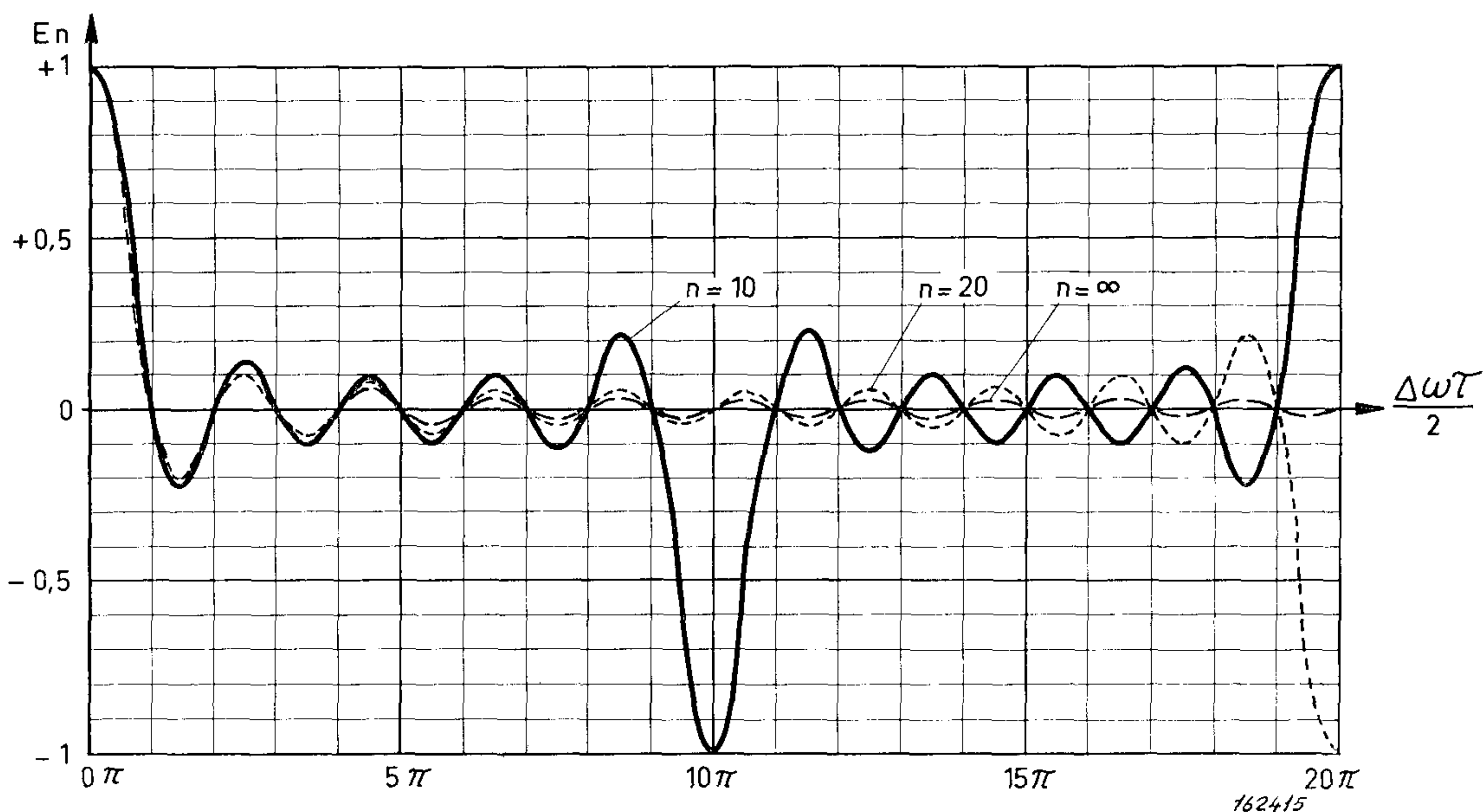

Fig. 8. Variation in the autocorrelation function for warbled tones and a band of noise as a function of bandwidth ($\Delta\omega$) and time difference (τ).

between the interference picture of a warbled tone and the equivalent noise-band, even if a bandwidth as high as 350 c/s is employed.

Also the effect of the bandwidth can be seen from Fig. 8. The relation $R(\tau) < 0.1$ is obtained for the first interference range when $\frac{\Delta\omega\tau}{2} = 3\pi$.

Again solving this for l gives:

$$l = \frac{3c}{2\Delta f}$$

This means that the greater the bandwidth, the narrower the disturbing interference range will be. In practice bandwidths greater than about 350 c/s are not very feasible for controlled warble tone or narrow-band noise generators, which means that the first strong interference range may be present up to distances around 1.5 m from the reflecting surface.

The above theory assumes perfectly reflecting surfaces. If the surface contains sound absorbing material this will affect the interference picture in that the calculated maxima are reduced.

Now, what is the significance of the difference in amplitude vs. time characteristics of the two types of signal with regard to room-acoustical measurements? This question may be answered by considering the linearity of acoustic absorbers commonly used for the acoustic treatment of rooms as well as the amplitude vs. time characteristics of "natural sounds". Most acoustic materials show an almost exact linearity over the range of sound levels encountered in normal music and speech rooms. However, certain types of Helmholtz resonators with relatively small "necks" show a distinct non-linearity with sound pressure level. This subject has been treated by L. I. Sivian, K. Uno Ingard and S. Labate (U.S.A.) and also by F. Barthel (Germany). Ingard and Labate suggested that non-linearity sets in at a sound pressure level of around 65 db. However, although non-linearity seems to be measurable at sound pressure levels around 80 db, serious non-linear effects in absorbers as applied to the acoustic treatment of rooms are not likely to be apparent at sound pressure levels lower than 110—120 db. In an experiment where a great number of resonators adjusted to a re-

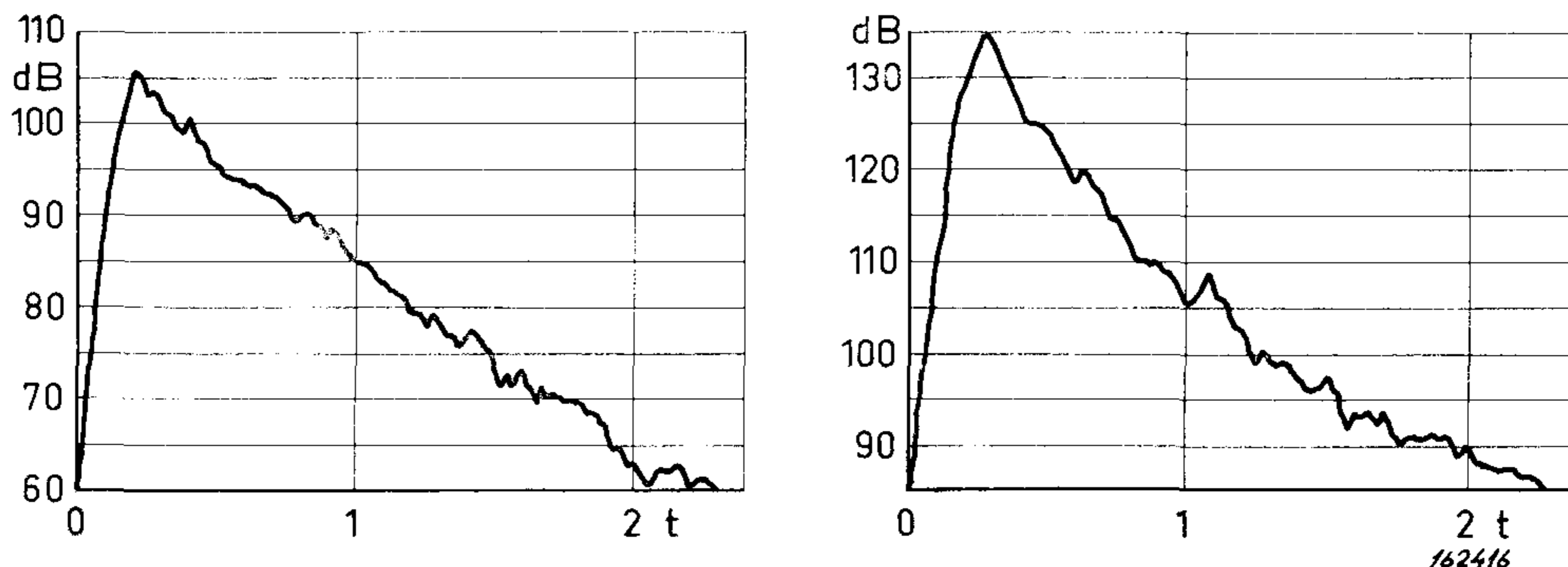

Fig. 9. Reverberation curves recorded for two different "starting" sound levels. The curves illustrate the dynamic non-linearities introduced due to the special resonators (Barthel).

sonance frequency of around 300 c/s were placed in a reverberation room, Barthel could, by simple reverberation measurements, show the effect of the non-linearity. In this case shots were used for the excitation and the recorded reverberation curves are shown in Fig. 9.

Measurements at Brüel & Kjær on a single resonator carried out by means of the standing wave method, also showed a distinct non-linearity with sound pressure level, although at considerably higher levels than those mentioned in the literature, Fig. 10.

The importance of non-linear effects, as regard the measuring signal suitable for acoustic tests, should as stated above be considered in view of the amplitude characteristics of "natural sounds" which in room-acoustics will be music and speech.

Typical amplitude density (probability density) curves of various signals are shown in Fig. 11, and the difference in amplitude density characteristics of "natural sounds" and of a warbled signal is clearly noticed.

As long as linear relationships hold true, and a fairly high modulation index is used for the warbled signal there will in practice be no significant measurement differences whether a warbled tone or the equivalent band of random noise is used as test signal. This will, in most cases, be valid in room-acoustic measurements. However, as soon as non-linearity enters the picture, the use of random noise becomes important. As an example of this category of problems some investigations have been made at Brüel & Kjær on the attenuation characteristics of an automobile muffler (silencer).

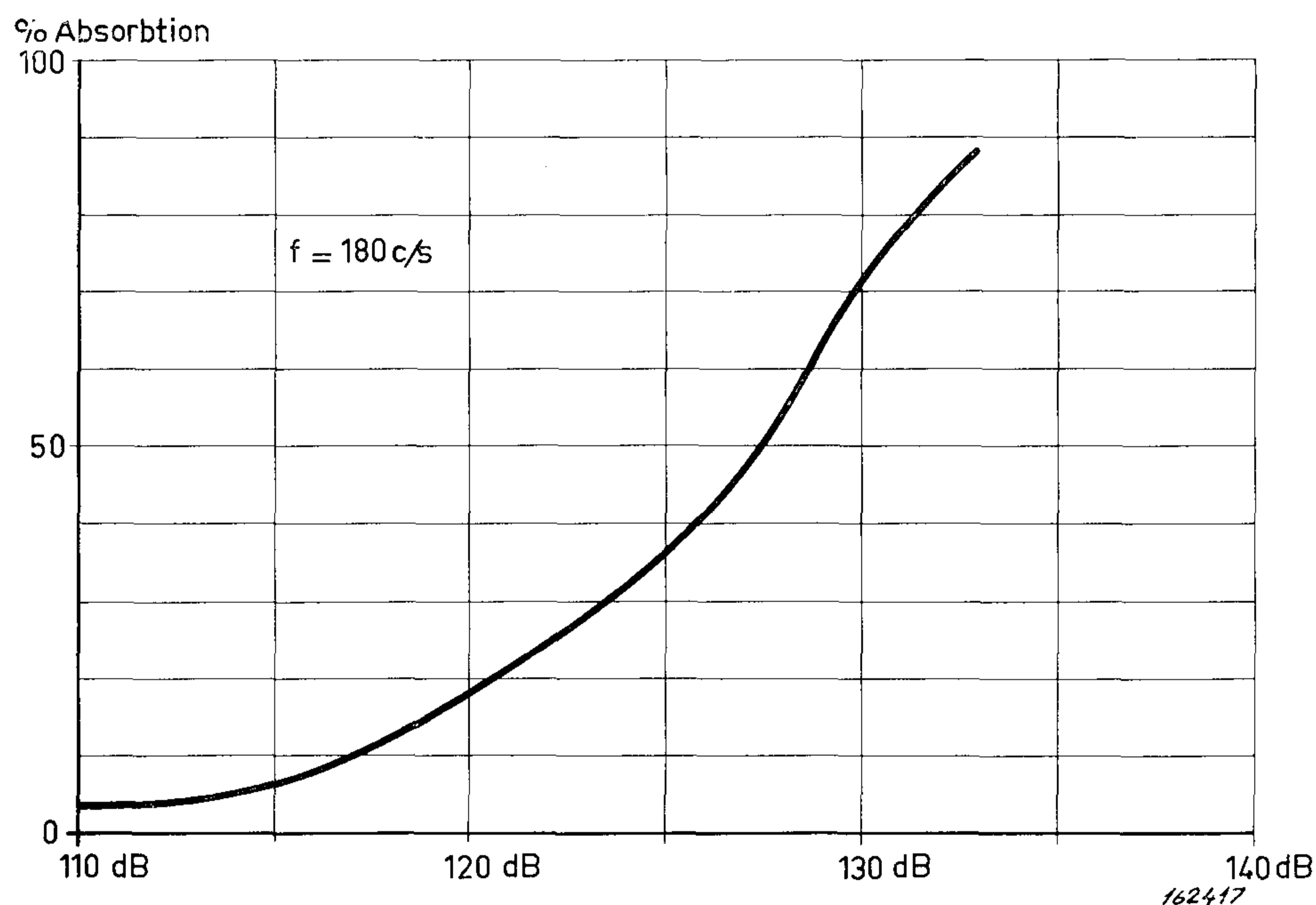

Fig. 10. Experimental results of measurements on a single resonator by means of the standing wave method.

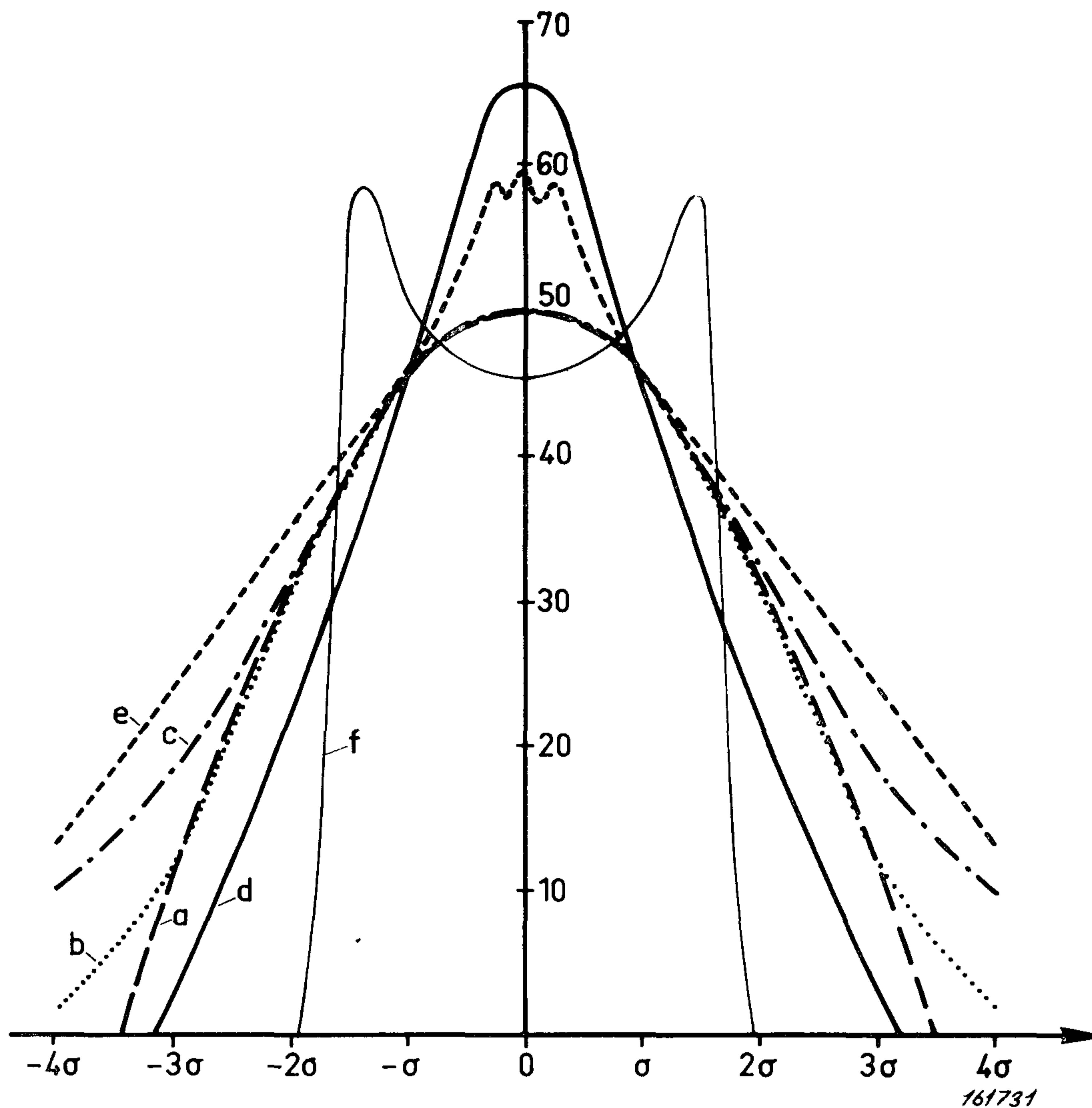

Fig. 11. Comparison of amplitude density curves.
 a) Random Noise.
 b) Noise from a mechanical workshop.
 c) Office noise.
 d) Music played by an orchestra.
 e) Speech in an auditorium.
 f) Warbled tones.

The muffler was first mounted on a car (Chevrolet, stationwagon 1961 model) and a $\frac{1}{2}$ " microphone Type 4134 installed as shown in Fig. 12. Tape recordings were then made on a high quality tape recorder (linear frequency response 2—2000 c/s) and the overall sound pressure levels monitored on a true R.M.S.-measuring amplifier (B & K Type 2112), both with idling engine and with the engine running at around full speed. The r.m.s. sound pressure levels were found to be in the region of 130—140 db re. 2×10^{-4} μ bar and an analysis of the instantaneous amplitude distribution showed amplitude density curves of the type given in Fig. 13. Pictures were also taken off the

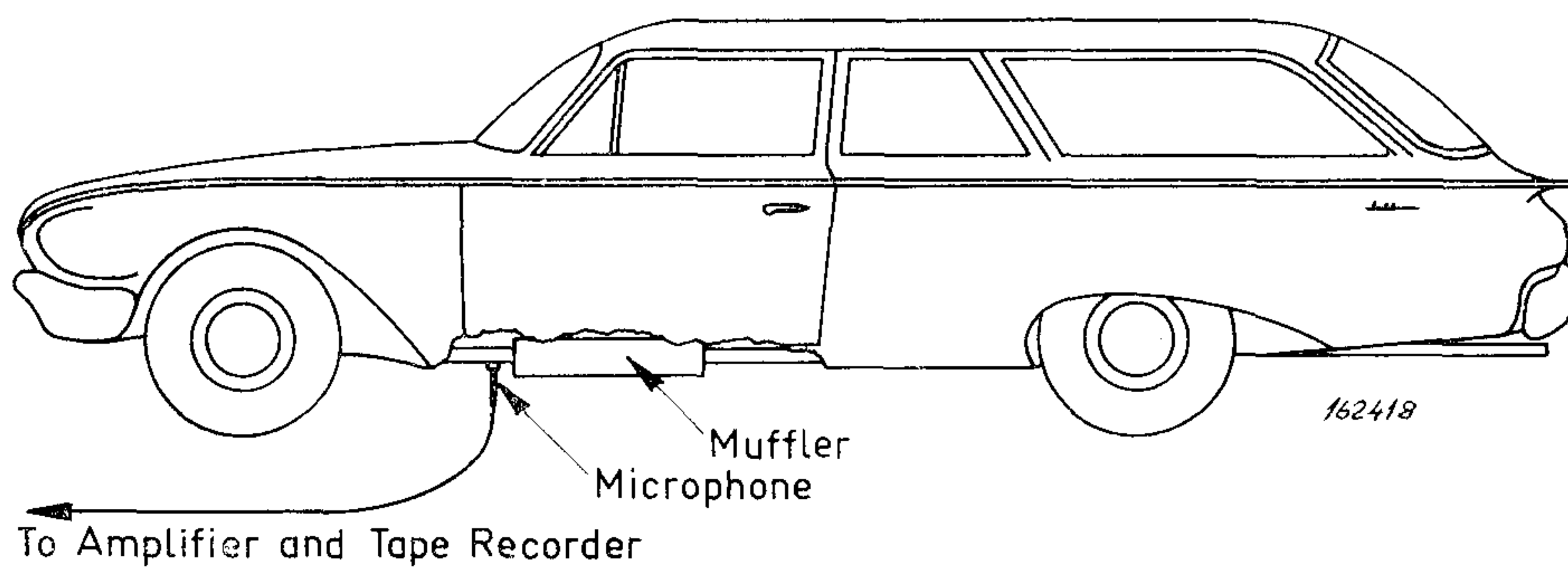

Fig. 12. Measurement of the amplitude density curve of the input noise to an automobile muffler. The sketch shows the installation of small microphone (B & K Type 4134) at the muffler input. To protect the microphone diaphragm from possible flames a probe "cap" filled with asbestos was fitted.

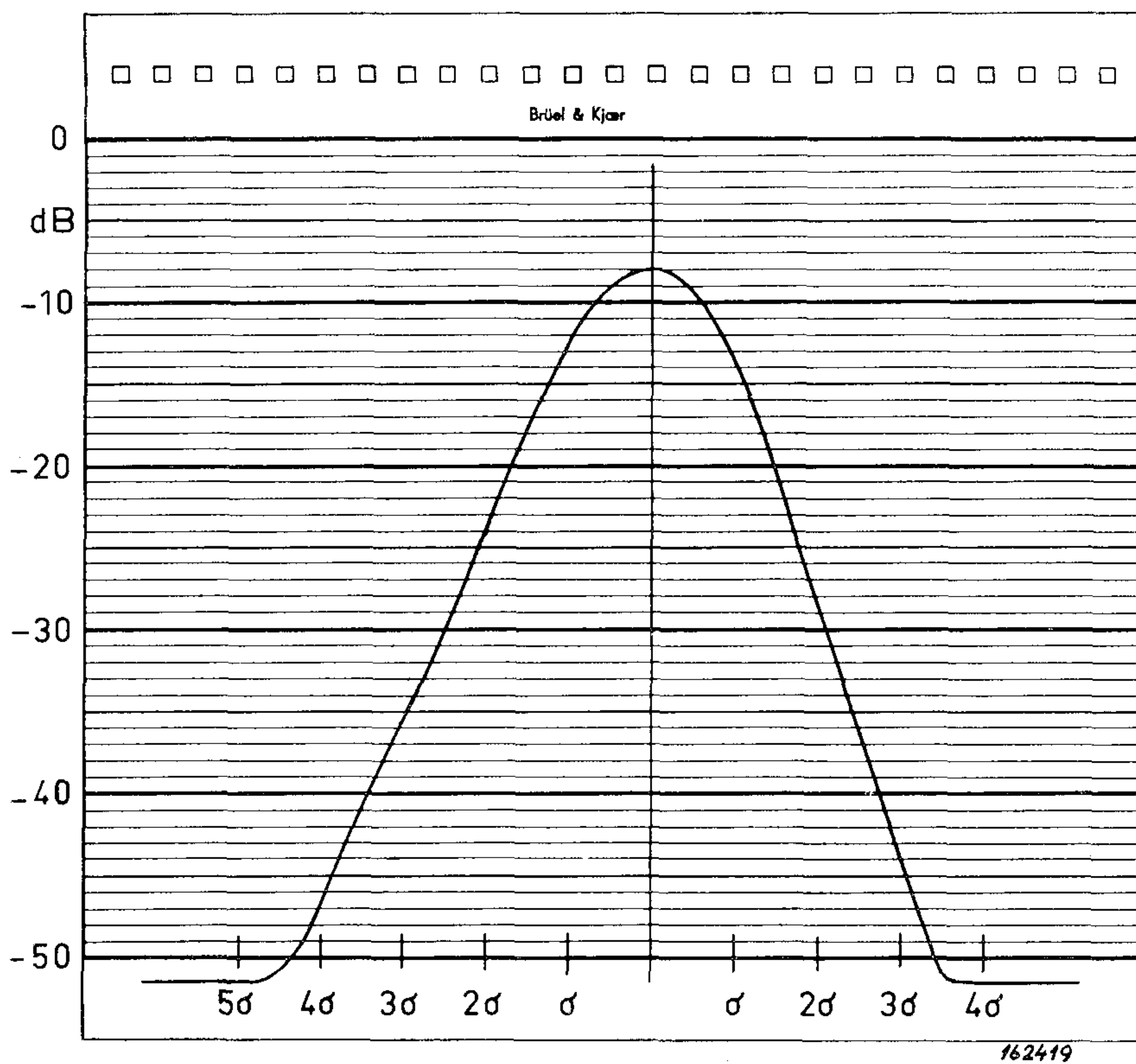
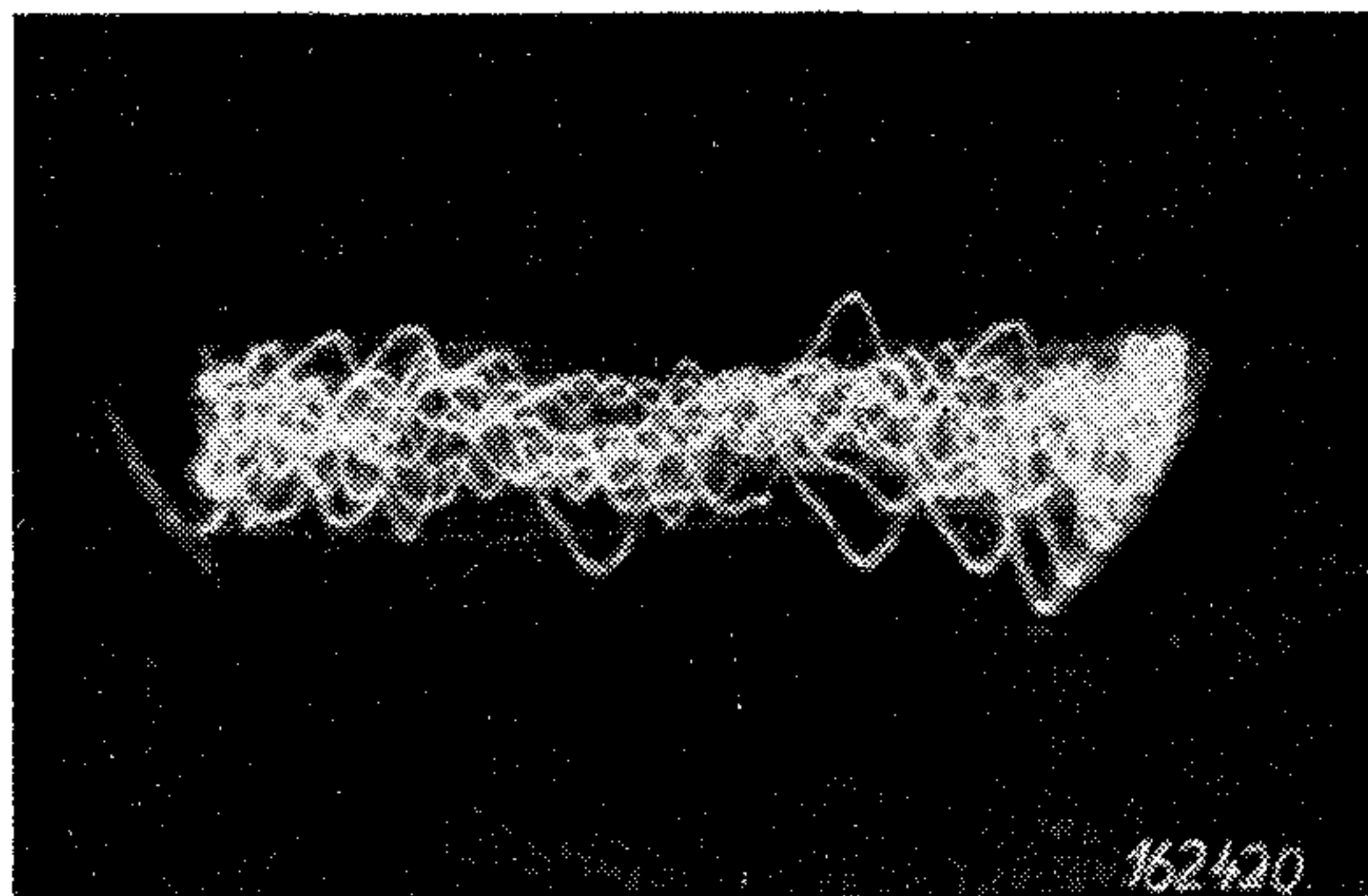
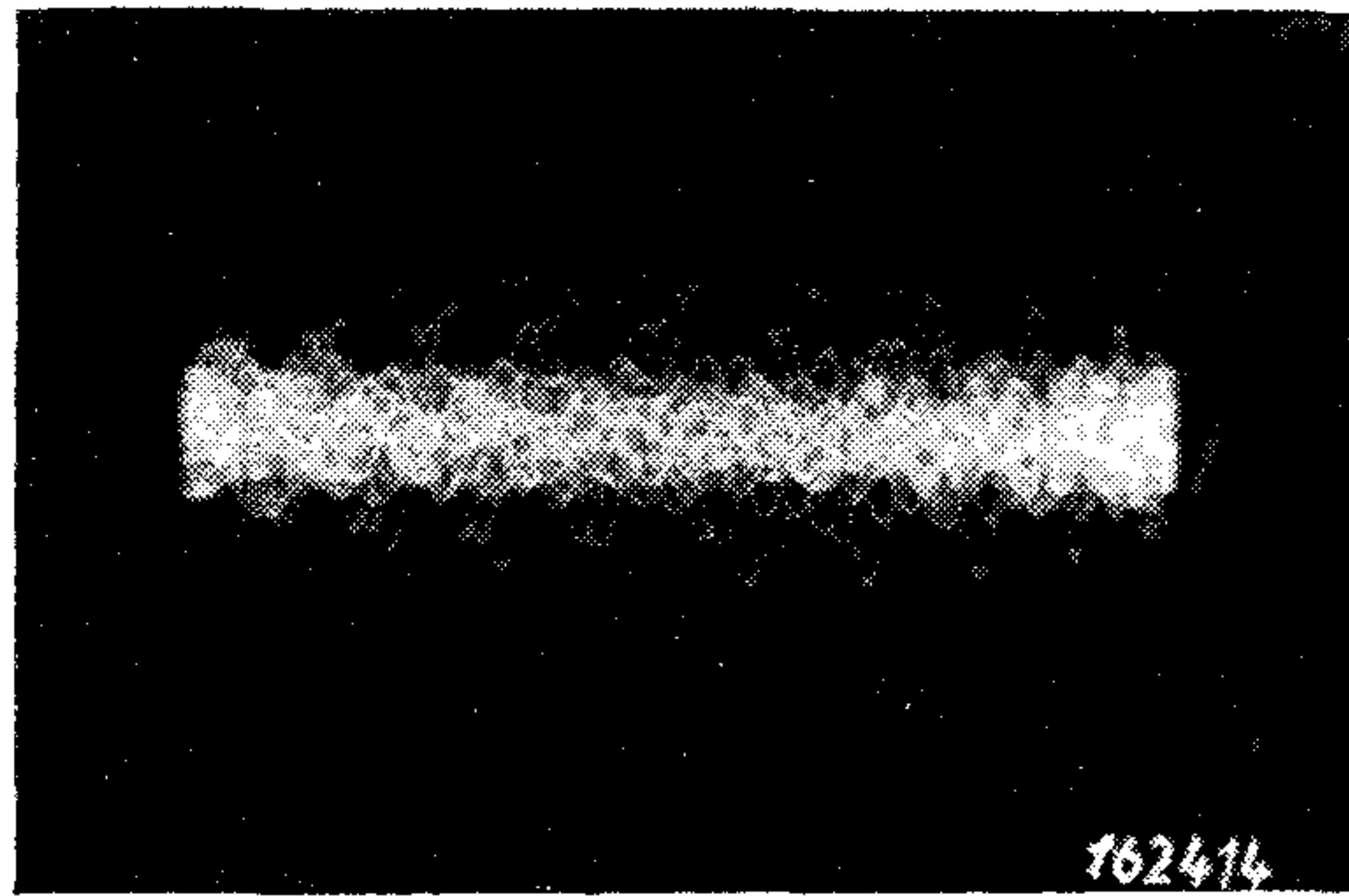

Fig. 13. Typical amplitude density curve measured at the muffler input.

screen of a cathode ray oscilloscope of the variation in waveform of the sound. One of the photos is reproduced in Fig. 14a and shows a fairly distinct periodicity in the sound waves, but a considerable variation in maximum amplitude with time. These characteristics are almost exactly those of narrow bands of noise, see Fig. 14b. This conclusion may also be drawn from the amplitude density curve shown in Fig. 13 and the 1/3-octave spectrogram of Fig. 15. The skewness in the amplitude density curve was also confirmed by the pictures on the oscilloscope screen.



a)



b)

Fig. 14. Time records of
 a) the input noise to the muffler
 b) a narrow band of random noise

To determine possible non-linearities in the muffler this was dismantled from the car and mounted on the Brüel & Kjær Constant Sound Pressure Source Type 4211 which is very well suited for measurements at low frequencies and with high sound pressure levels.

By feeding the muffler first with sinusoidal sound waves of constant R.M.S. levels (113 db and 126 db) and then with narrow bands of noise ($\Delta f = 10$ c/s) at the same R.M.S. input sound pressure levels the curves shown in Fig. 16 were recorded at the muffler output. The difference between the curves are clearly noticed and are due partly to the difference in "bandwidths" of the sweeping signals and partly to some slight nonlinearities in the muffler.

From the foregoing theoretical discussion and practical experiments the following conclusion may be drawn on the use of warbled tone and bands of random noise for acoustic measurement purposes:

1. Wherever acoustic measurements are to be made in spaces or on equipment designed for operation in complex sound fields and where non-linearities are present, bands of random noise should be used as test signals.
2. If measurements are to be made in spaces or on equipment which behave strictly linearly with sound pressure level, warbled tones may be used as

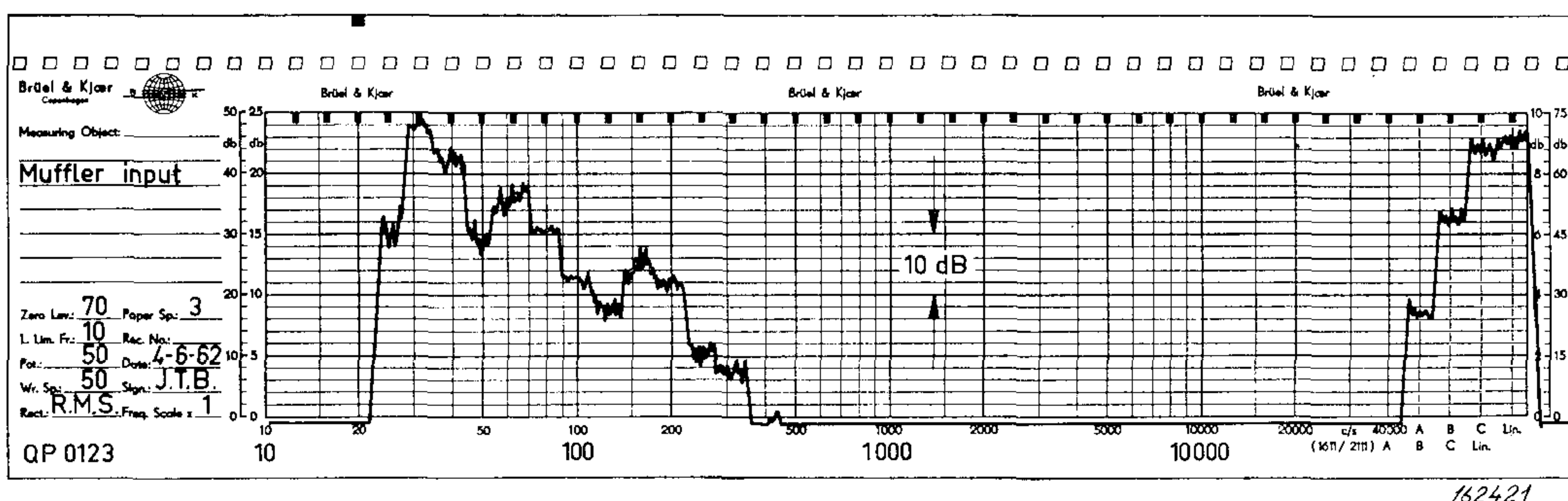

Fig. 15. Spectrogram of the muffler input noise. The rapid fall-off in amplitude vs. frequency is partly due to the probe "cap" on the microphone.

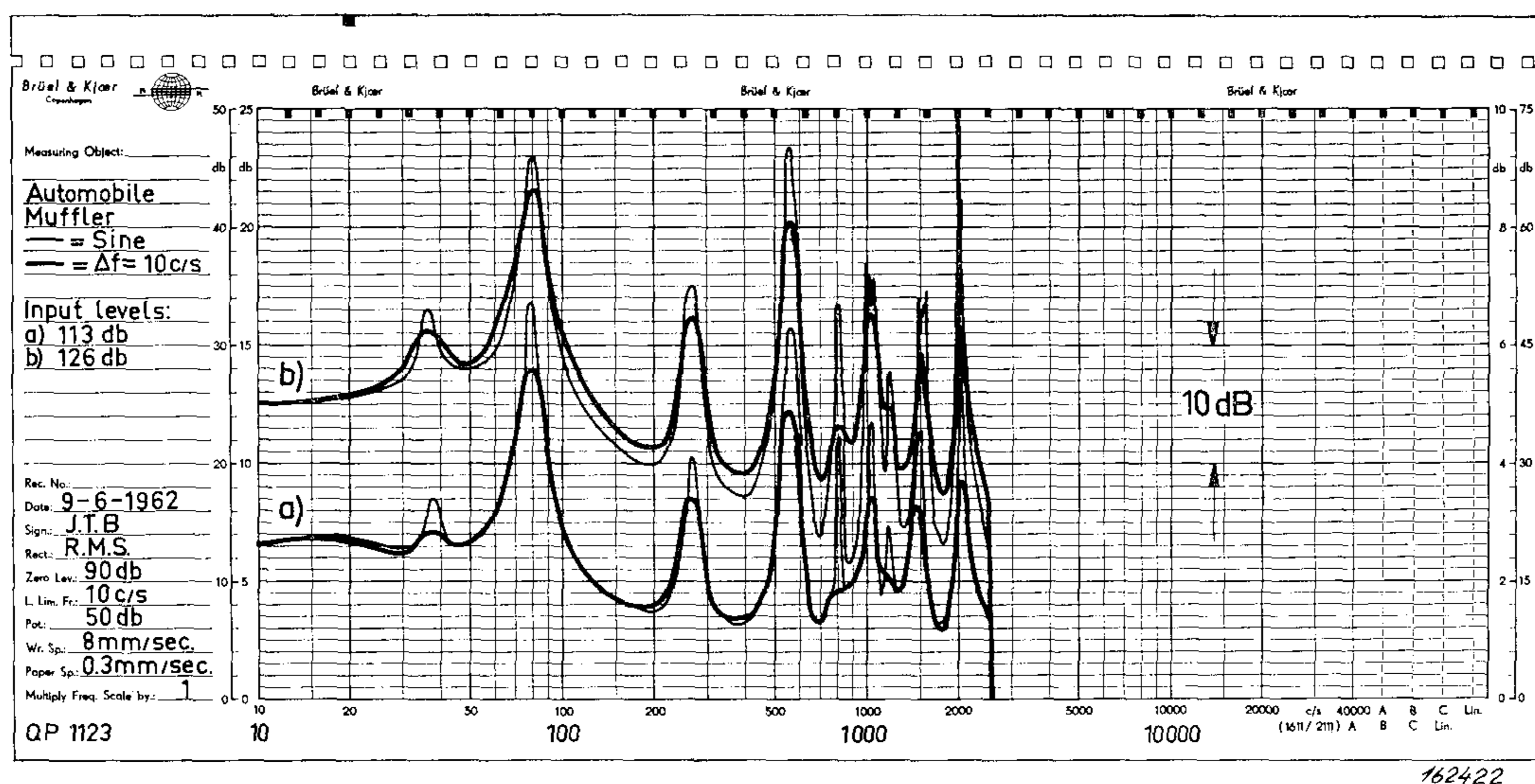

Fig. 16. Output sound pressure vs. frequency curves with constant input level on the muffler.

- a) with sinusoidal input
- b) with a sweeping band of noise input

test signal instead of random noise, even if the sound field in actual operation is random in nature.

The discussion in this paper has been mainly concerned with measurement problems in room acoustics and noise control. However, also in electro- and psycho-acoustics, the use of complex test signals is sometimes convenient, such as in the testing of loudspeakers and experiments on the masking effect of the ear. In these cases the above conclusions regarding the choice of test signal type still hold true, and it may be generally stated that when a complex test signal is wanted, bands of random noise will be the most desirable type of signal to use, while economical considerations may sometimes result in the substitution of this type of signal with warbled tones.

Bibliography

- BARTHEL, F.: Über den Strömungswiderstand Poröser Bausteine. *Acoustica* Vol. 6 (1956), p. 259.
- BARTHEL, F.: Untersuchungen über nichtlineare Helmholtzresonatoren. *Frequenz* (1958), Heft 3.
- BROCH, J. T. Automatic Recording of Amplitude Density Curves. B & K Technical Review No. 4—1959.
- BROCH, J. T.: The Application and Generation of Audio Frequency Random Noise. B & K Technical Review No. 2—1961.
- BRÜEL, P. V.: Sound Insulation and Room Acoustics.
- DAVIS, D. R. Jr.: Acoustical Filters and Mufflers. Contained in Cyril M. Harris: *Handbook of Noise Control*, Chapter 21. McGraw-Hill 1957.
- FELDTKELLER, R. and ZWICKER, E.: *Das Ohr als Nachrichtenempfänger*. S. Hirzel Verlag, Stuttgart 1956.

- INGARD, U. and LABATE, S.: Acoustic Circulation Effects and the Nonlinear Impedance of Orifices. J.A.S.A. March 1950. (Vol. 22, p. 211—218).
- INGARD, U.: On the Theory and Design of Acoustic Resonators, J.A.S.A. November 1953. (Vol. 25, p. 1037—1061).
- KARNOVSKI, M. I.: On the Comparison of the Usefulness of Bands of White Noise, Multitones and Warbled Tones for Acoustic Measurements in Rooms. Kiev Institute for Motion Picture Engineers, May 1953. Published in the "Work of the Acoustic Commission", Collection 8, 1955, pp. 160—167. (In Russian).
- RYBNER, J.: Fourier Analysis of Frequency Modulated Vibrations with Sawtooth Variation of the Instantaneous Frequency (Warbling). Publication No. 2. Akademiet for de Tekniske Videnskaber, Copenhagen 1946.
- SIVIAN, L. J.: Acoustic Impedance of Small Orifices. J.A.S.A. October 1935 (Vol. 7, p. 94—101).

Problems in Feedback Control of Narrow Band Random Noise*)

By *P. E. Møller Petersen.*

ABSTRACT

The experimental heterodyne noise generator which is described in this paper can supply Narrow Band Noise with constant absolute bandwidth and continuously variable center frequency. The bandwidth of the noise can be adjusted to 10, 30, 100 or 300 c/s and the center frequency can be varied between 20 c/s and 20 kc/s. The generator has a compressor circuit for automatic output voltage regulation by means of which, for example, sound pressure or vibration level can be maintained constant.

The magnitude distribution of the output voltage is in accordance with the Gaussian distribution law also when the compressor circuit is used. To ensure this, the time constant of the regulation circuit must be high enough to prevent unwanted regulations of the noise signal envelope.

The maximum permissible regulation speed has been found by measuring peak response distribution at different time constants.

Considering the test time, the compressor speed should be as high as possible without affecting the magnitude distribution of the output voltage, since the maximum permissible scanning speed depends on the selected compressor speed.

The instrumentation set-up developed for recording the peak response distribution of the output voltage includes, besides a level recorder, a rectifier section which can apply either the positive or the negative envelope to an oscilloscope, in front of which a photomultiplier tube is mounted. By-passing the rectifier circuit, the instantaneous voltage response can be recorded.

SOMMAIRE

Le générateur hétérodyne expérimental décrit dans cet article produit autour de la fréquence variable de son signal de sortie une Bande Etroite de Bruit de largeur constante en valeur absolue. La fréquence centrale du signal varie de 20 Hz à 20 kHz et la largeur de bande peut être de 10, 30, 100 ou 300 Hertz. Une particularité importante de ce générateur de bruit est son circuit servo-régulateur permettant de maintenir constante la grandeur de sortie en conditions variables (pression sonore ou vibration par exemple).

La distribution statistique en amplitude du signal est gaussienne et le reste malgré l'emploi du régulateur si la constante de temps de régulation est suffisamment longue pour éliminer les risques de régulation de l'enveloppe du signal.

*) Paper given at the 4th ICA-Congress, Copenhagen 21.—28. august 1962.

La constante de temps minimum a été déterminée en étudiant son influence sur la distribution du signal de crête de sortie. Elle correspond à la vitesse maximum de régulation et fixe donc la vitesse maximum possible de balayage de la gamme de fréquence, dans l'étude d'un phénomène donné.

L'appareillage employé pour la détermination des distributions statistiques d'amplitudes comprend un redresseur à la sortie duquel l'enveloppe, soit positive soit négative du signal est recueillie et envoyée sur l'écran d'un oscilloscope. Un tube photo-électrique mesure les amplitudes et son signal de sortie est enregistré en fonction du temps. Il est également possible en supprimant le redresseur de faire l'étude des tensions instantanées.

ZUSAMMENFASSUNG

Die hier beschriebene Versuchsausstellung eines Schwebungssummers, kann ein schmalbandiges Rauschen von konstanter Bandbreite und kontinuierlicher, veränderlicher Mittenfrequenz erzeugen. Die Rauschbandbreite kann auf 10, 30, 100 oder 300 Hz (c/s) eingestellt werden und die Mittenfrequenz ist abstimbar zwischen 20 Hz (c/s) und 20 kHz (kc/s). Der Generator ist mit einem automatischen Regelkreislauf (Kompressor) versehen, wobei es möglich ist, in einer Meßaufstellung einen konstanten Effektivwert der Spannung, Strom, Schalldruck oder Schwingungspegel zu halten.

Die Augenblickswerten der Ausgangsspannung sind gaussisch (Normal) verteilt; auch wenn die automatische Regelung (Kompressor) eingeschaltet ist. Um dies zu erreichen, muss die Zeitkonstante des Regelkreislaufes so gross sein, daß sie nicht der Umhüllungskurve des Signals folgen kann.

Die maximale, zulässige Regelungsgeschwindigkeit ist durch das Messen der Spitzenverteilung bei verschiedenen Zeitkonstanten bestimmt worden.

Da die maximale erlaubte Frequenzdurchlaufgeschwindigkeit durch die Regelzeitkonstante bestimmt ist, sollen diese so klein wie möglich gewählt werden, mit Rücksicht auf unzerstörte Spitzenverteilung des Ausgangssignals, um die Meßzeit niedrig zu halten.

Die Meßaufstellung, die für die Messung der Spitzenverteilung entwickelt ist, besteht aus einem Gleichrichter, der, entweder die positive, oder negative Umhüllungskurve des Signals an dem Y-Plattenpaar eines Kathodenstrahloszillographen zuführt, sowie eine Photoverstärkerröhre, die mit einem kleinen Schlitz versehen ist und auf dem Kathodenstrahloszillographen montiert werden kann, sowie einem Pegelschreiber. Wenn der Gleichrichter »überbrückt« wird, kann die Verteilungskurve der Signalausgangswerten gemessen werden.

Introduction.

Random Noise has been used for acoustical test purposes for several years and a large number of noise generators with various frequency characteristics are available. Most commonly the output of the generators can be characterized as white noise which means that the energy per unit frequency is constant through the frequency range of interest. Generators intended for applications where filters with constant percentage bandwidth are involved can in addition often supply a noise spectrum where the output voltage per unit frequency decreases 3 db per octave. This type of noise is sometimes described as pink noise. There are also noise generators capable of generating noise in selectable frequency bands, for example one octave or one third of an octave.

The purpose of the generator described in the following is to produce narrow band random noise with constant absolute bandwidth and continuously variable center frequency in the audio frequency range.

The generator utilizes the heterodyne principle which has made it possible to incorporate automatic feedback control of the output voltage. The feedback circuit has been so designed that Rayleigh distribution of the output peaks can be maintained over a compression range of 45 db. Some of the problems which arose during the development work will be discussed in this paper and an instrumentation set-up for recording peak response probability density curves will be described.

Description.

The block diagram in Fig. 1 shows the different sections of the Generator. The basic noise signal is produced in the Noise Generator section where the noise from 2 silicone diodes is added and amplified.

The silicone diode is an excellent noise source as far as frequency spectrum is concerned, but the magnitude distribution is unsymmetrical and not gaussian. This drawback can be overcome by adding the signals from two diodes.

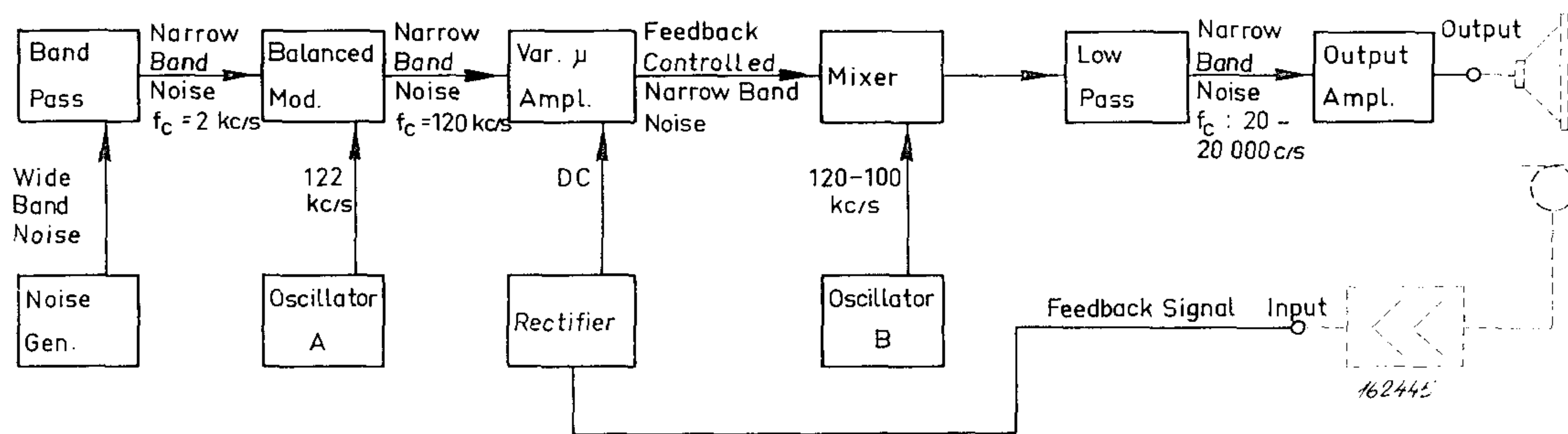

Fig. 1. Block diagram of the Narrow Band Noise Generator.

The noise generator is followed by a band pass filter which determines the bandwidth of the final output noise band. The center frequency of the pass band is 2000 c/s. Fig. 2 shows the attenuation characteristics.

In the Balanced Modulator following the band pass filter, the center frequency of the noise band is converted to 120 kc/s by beating with a 122 kc/s sine wave signal.

The unwanted frequencies, which include among others the 122 kc/s from the sine wave oscillator, the 2 kc/s noise signal and the 124 kc/s sum frequency, are rejected partly in the balanced modulator and partly in the following selective variable μ amplifier which also forms an important part of the feedback control circuit.

As a net result a narrow band noise signal with a center frequency of 120 kc/s is present at the output of the variable μ amplifier the bandwidth being adjustable to 10, 30, 100 or 300 c/s.

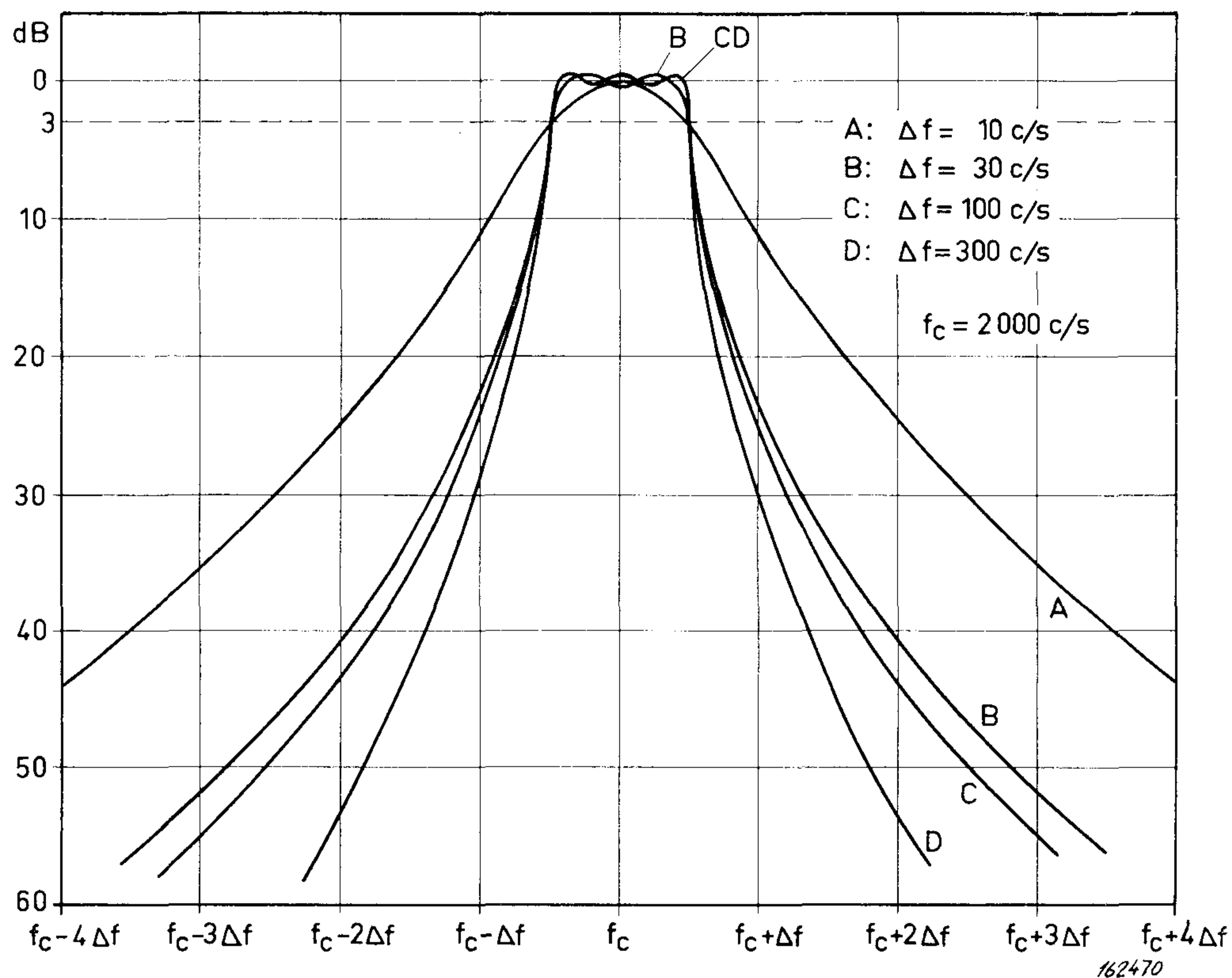

Fig. 2. Band-pass filter attenuation characteristics.

The final output center frequency is produced by a second frequency conversion where the 120 kc/s noise signal is beaten with the signal from Oscillator B the frequency of which is continuously variable in the range 120 to 100 kc/s by means of a tuning condenser. This condenser is specially designed to give a logarithmic variation of the output frequency and intended for outside motor drive.

The narrow band noise signal the center frequency of which is now variable between 20 and 20000 c/s is passed through a low pass filter to the output amplifier and is finally available at the output terminals.

The r.m.s. value of the output voltage is indicated by an output meter the damping of which can be altered by changing the time constant of a Miller integrator incorporated in the rectifier circuit. At a bandwidth of 10 c/s a meter time constant of 30 seconds is used.

The output signal level is practically independent of the center frequency and will remain constant during a frequency sweep.

For many applications, however, other quantities such as current, sound pressure or vibration level should be kept constant.

For this purpose a voltage proportional to the quantity to be regulated can be applied to the input of a "compressor" circuit.

The feedback signal which may be the amplified voltage from a condenser microphone as indicated in Fig. 1 is rectified and used to regulate the gain in the variable μ amplifier thereby automatically controlling the output voltage and keeping the quantity in question constant.

Magnitude Distribution.

Oscillograms of narrow band Gaussian random noise of different bandwidths are shown in Fig. 3. It may be seen that the appearance is similar to that of an amplitude modulated sine wave signal. The instantaneous response is distributed according to the Gaussian distribution and the peak response or envelope according to the Rayleigh distribution. See Fig. 4.

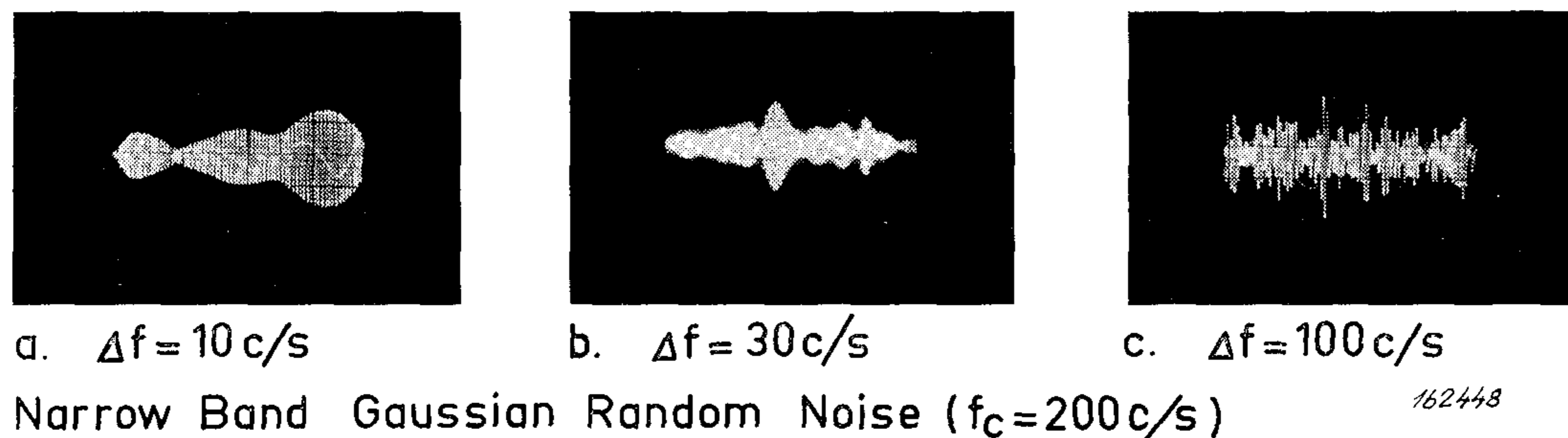

Fig. 3. Narrow Band Gaussian Random Noise ($f_c = 200 \text{ c/s}$).

The narrow band noise output from the generator described must be in accordance with these distribution curves when working with as well as without feedback control.

The magnitude distribution of the output from the basic wide band noise generator is not critical as only a very small frequency band is passed through the following filter but all the amplifier sections including the Band Pass Filter and the Variable μ Amplifier must have a linear voltage characteristic.

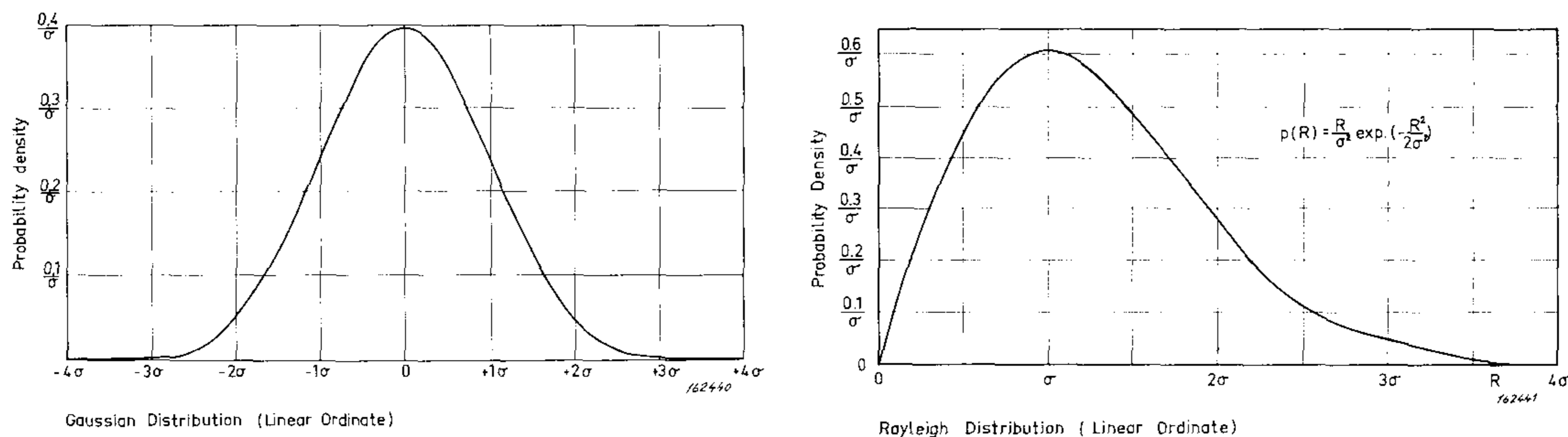

Fig. 4. The Gaussian and the Rayleigh distribution curves.

In the variable μ amplifier the gain is controlled by the rectified feedback signal which is used as bias voltage for two amplifier tubes working near cut-off. To obtain a sufficiently linear voltage characteristics here, it has been necessary to operate at very low signal levels.

The voltage characteristic for the complete Narrow Band Noise Generator measured with sine waves from the input of the band pass filter to the output terminals can be seen in Fig. 5, which shows the output voltage as a function of input voltage with the compression as parameter.

Compressor Speed.

To maintain Rayleigh distribution during automatic frequency scanning when the output voltage is feedback controlled, a sufficiently low compressor speed is just as important as a linear voltage characteristic. Too high a compressor speed will cause unwanted regulation of the noise signal envelope, the compressor trying to keep the amplitude constant. See Fig. 6.

The speed of the compressor is determined by the time constant of the rectifier for the feedback signal and can be adjusted in steps of 3 to 1. The time constant required for a particular test is a function of the band-

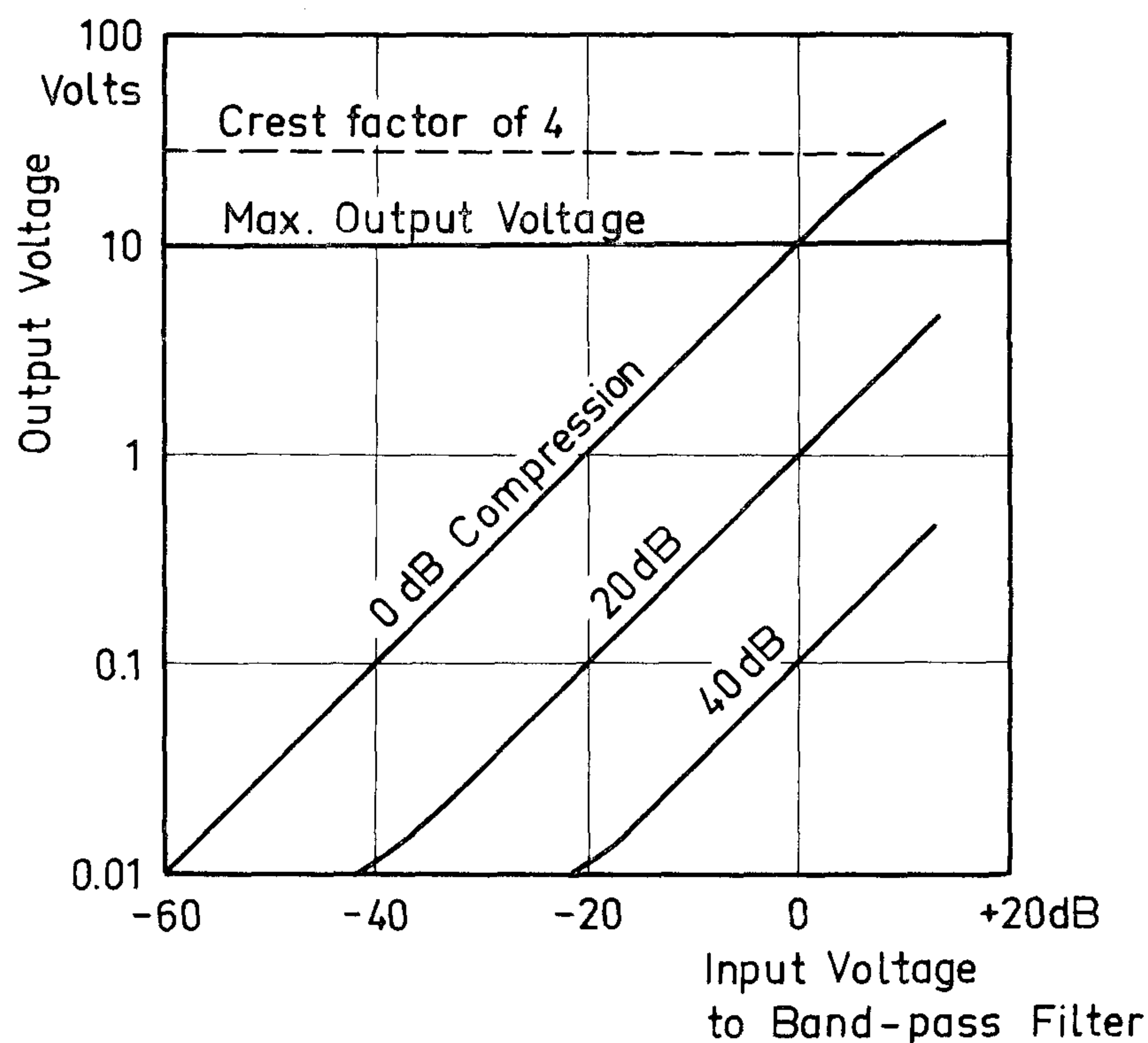

162471

Fig. 5. Voltage characteristics for band-pass filters, amplifiers and mixer stages.

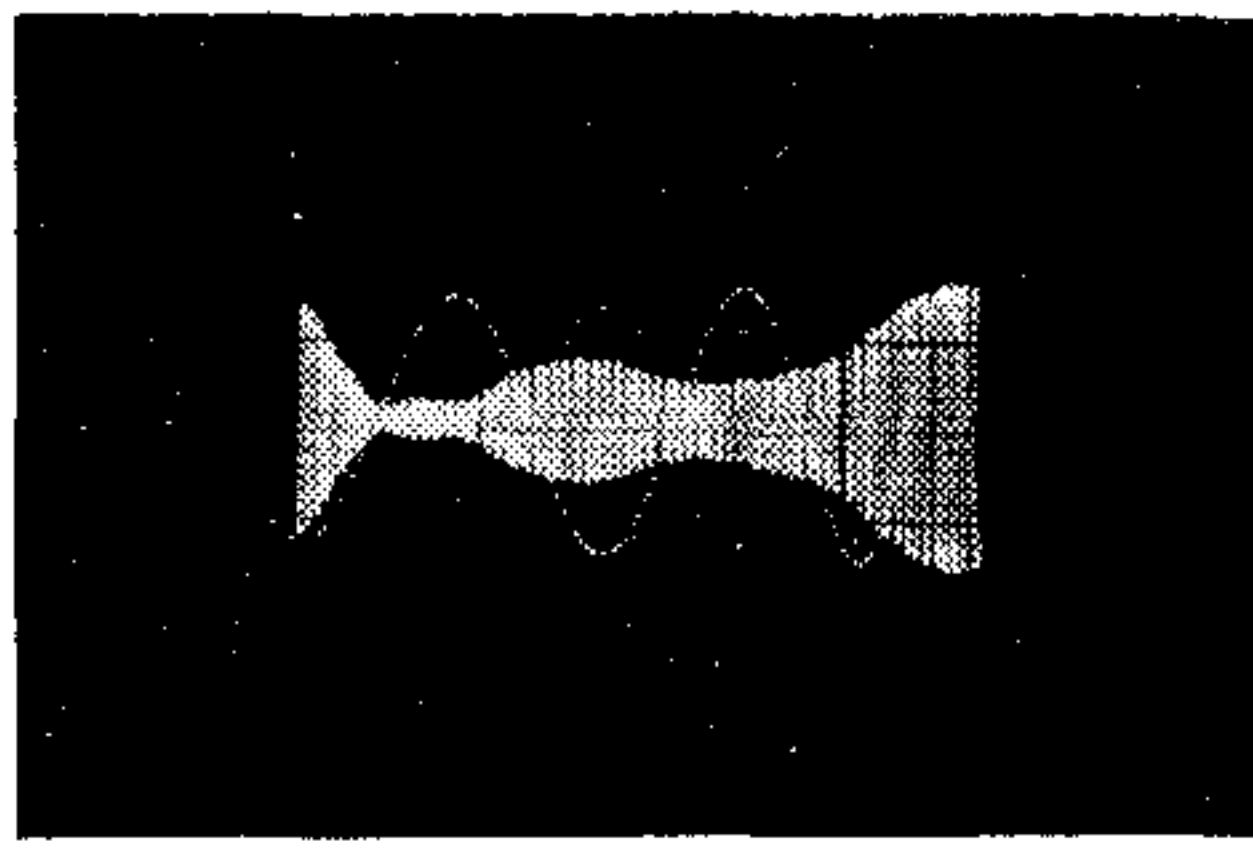

a. 3 dB/sec.

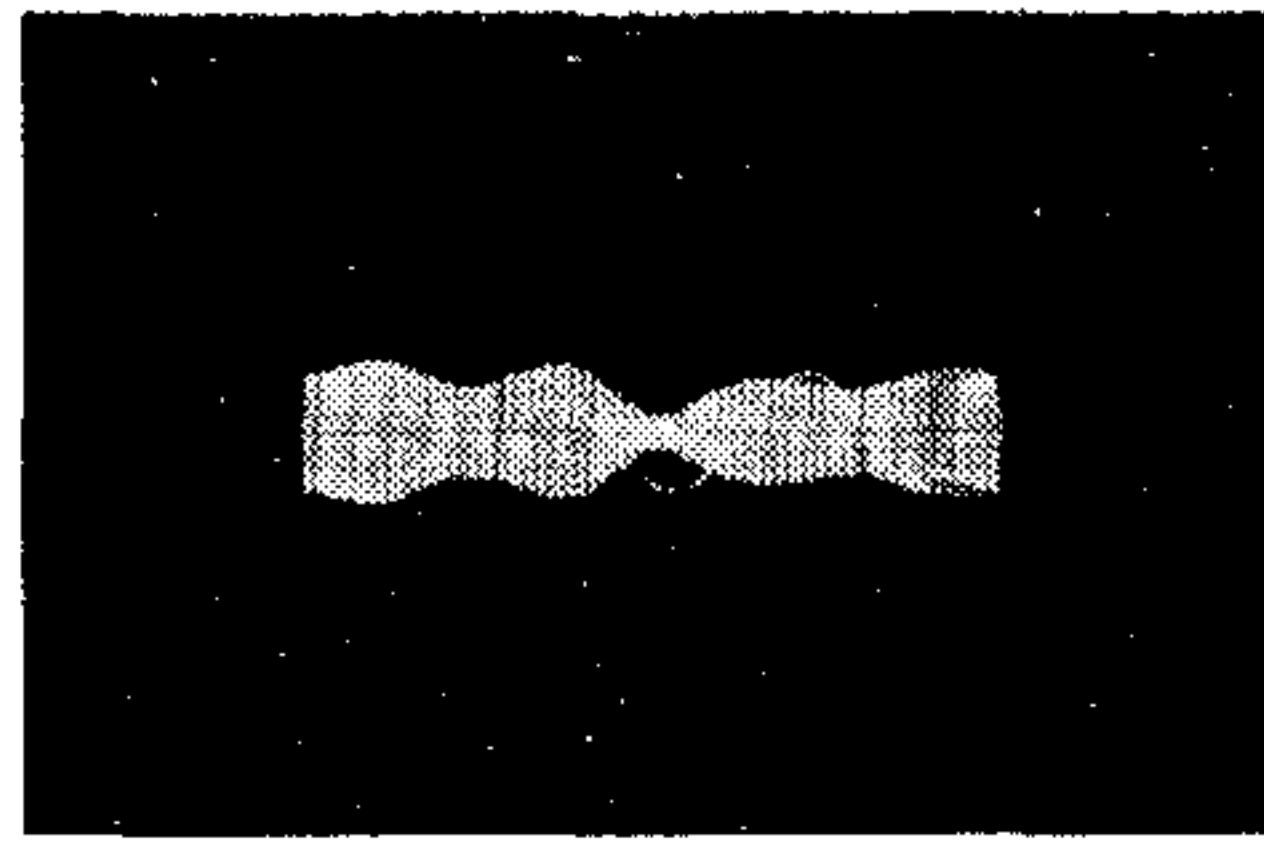

b. 100 dB/sec.

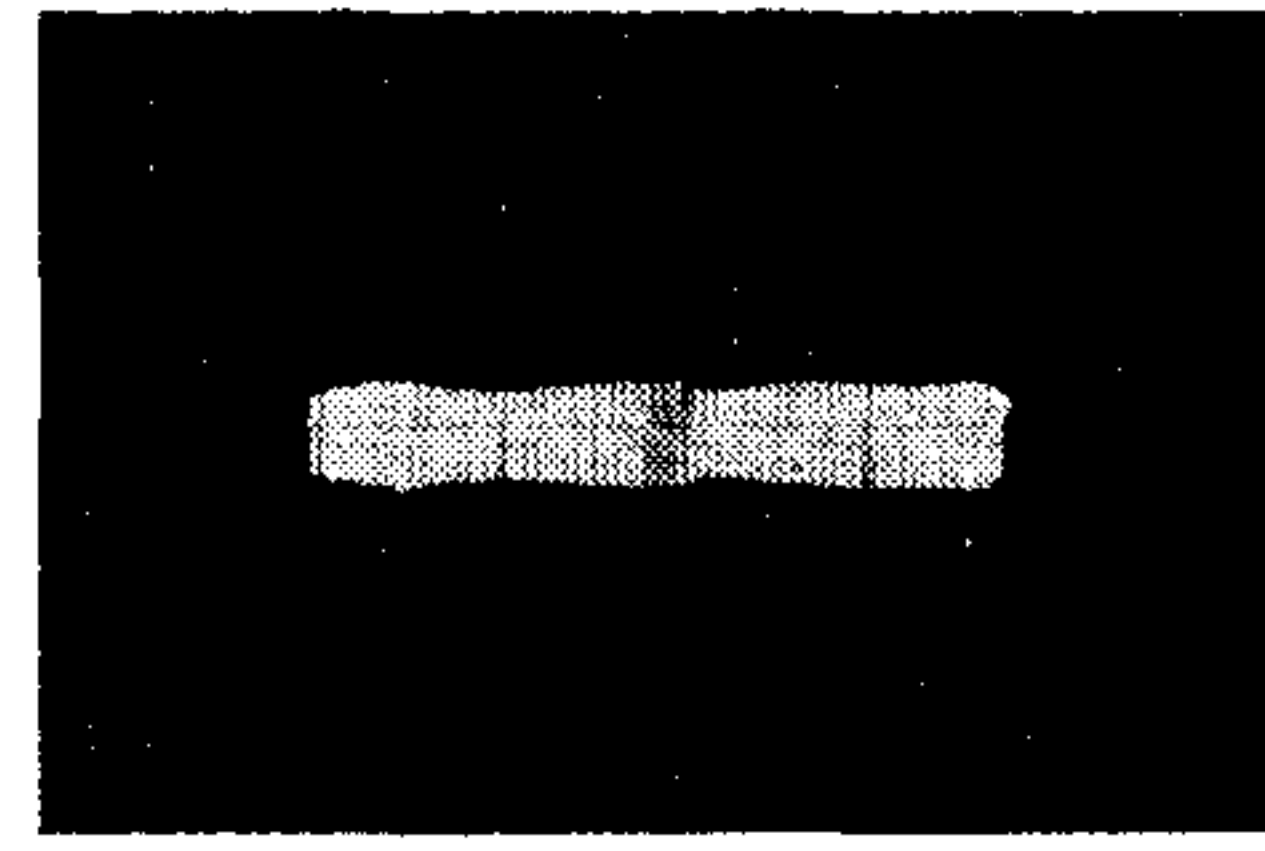

c. 3000 dB/sec.
162449

The Effect of too high Compressor Speed
($f_c=200$ c/s ; $\Delta f=10$ c/s)

Fig. 6. The effect of too high compressor speed.

width of the output signal, and the compressor speed should be selected according to table 1.

Scanning Speed.

The maximum permissible scanning speed depends on the selected compressor speed as the change in frequency must take place at such a rate that the compressor has time to correct the output level.

Considering the test time the compressor speed should thus be as high as possible without affecting the magnitude distribution of the output voltage. This has been the decisive factor in the choice of type of rectifier for the feedback signal.

Rectifier Considerations.

The first aim was to incorporate a square law detector as the r.m.s. value of the reference signal should be kept constant during the frequency sweep, but with this design of rectifier, the compressor speed for increasing and decreasing reference voltages are different. For increasing levels the regulation is faster and thus determined by the bandwidth of the output voltage. The maximum possible scanning speed, however, will depend on the slower compressor speed at decreasing levels and an unnecessarily long test time will result.

In order to obtain equal compressor speeds for increasing and decreasing levels, thereby reducing the test time, an average absolute rectifier has

Bandwidth	c/s	10	30	100	300
Compressor Speed	dB/sec	3	10	30	100

162447

Table. 1. Recommended compressor speeds.

been chosen for the compressor circuit. The average value of the reference signal is thus kept constant during the frequency sweep instead of the r.m.s. value, but in practice this is of no significance as the ratio between the r.m.s. value and the average value of the feedback signal is constant (approx. 2 db) for normal applications where the magnitude distribution of the reference signal is gaussian.

Recording of Probability Density Curves.

The figures in table 1 have been found by measuring the magnitude distribution of the positive as well as the negative envelope of the output signal at different bandwidths and different compressor speeds. At correct compressor speed the probability density curve of the envelope will obey the Rayleigh distribution law.

The instrumentation developed for recording the distribution curves includes a rectifier section which can be switched to apply either the positive or the negative envelope to the Y-deflection input of a DC oscilloscope having a short persistence cathode ray tube. The front of the tube is masked by a plate of ebonite with a one millimetre high slit in it and the light passing through the slit reaches a photo multiplier tube mounted in front of the oscilloscope as shown in Fig. 7.

The voltage balance in the Y-amplifier output stage can be varied by an external motor drive so that the picture of the envelope is moved slowly from the top to the bottom of the screen. During the movement the current in the photo multiplier will change, being proportional to the time for which the voltage of the envelope has a value causing the electron beam to be opposite the slit in the mask.

After several experiments with different cathode ray tubes, different shapes of slit, and different amplitudes of picture on the screen a linear working range of 50 db has been obtained.

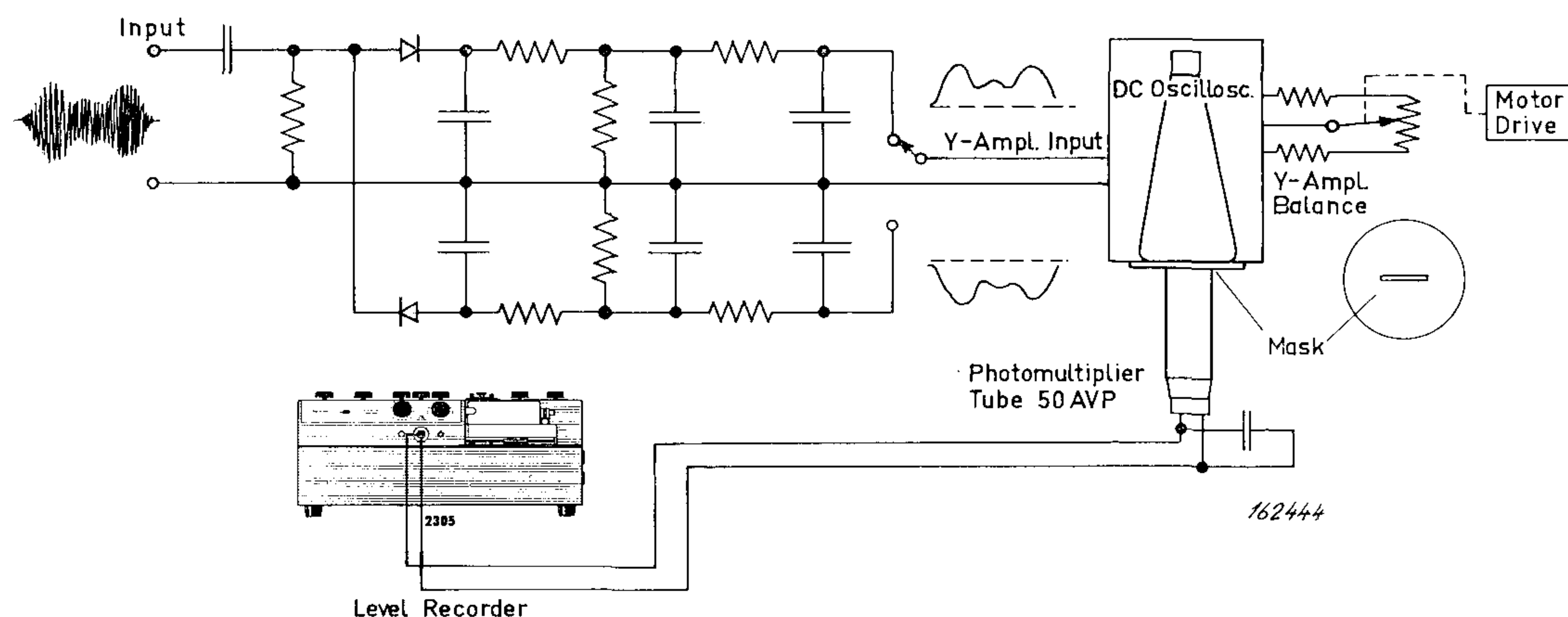

Fig. 7. Instrumentation for recording peak response distribution curves.

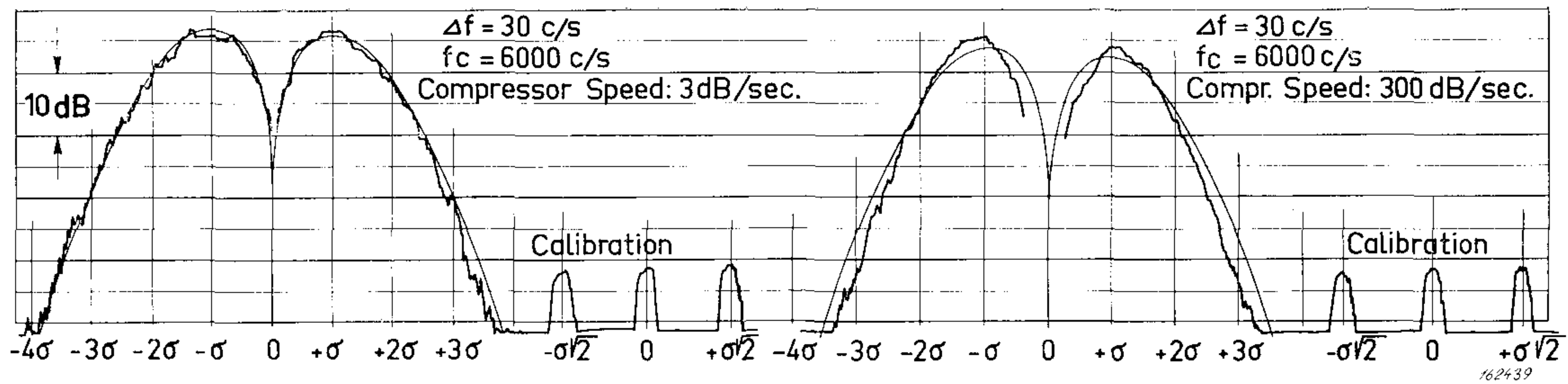

Fig. 8. Peak response distribution curves for different compressor speeds.

By moving the picture of the envelope relative to the slit and applying a voltage proportional to the photo multiplier current to a level recorder the probability density curves can be recorded.

Fig. 8 shows as an example the distribution curves for a noise signal with 30 c/s bandwidth at compressor speeds of 3 and 300 db/sec. At 300 db/sec the depression of the higher amplitudes is easily detected. The integrating network, which is averaging the voltage applied to the level recorder, must have a time constant at least in the order of 100 seconds when the bandwidth of the noise is 30 c/s. The recording time is consequently fairly long: for each of the distribution curves shown in Fig. 8 the time used was 6 hours.

As may be seen from the curves, first the magnitude distribution of the negative envelope and then that of the positive is recorded.

The calibration is carried out by applying a sine wave signal having the same r.m.s. value as the investigated signal to the input of the rectifier, and then recording first the negative peak value, then the zero line, and finally the positive peak value.

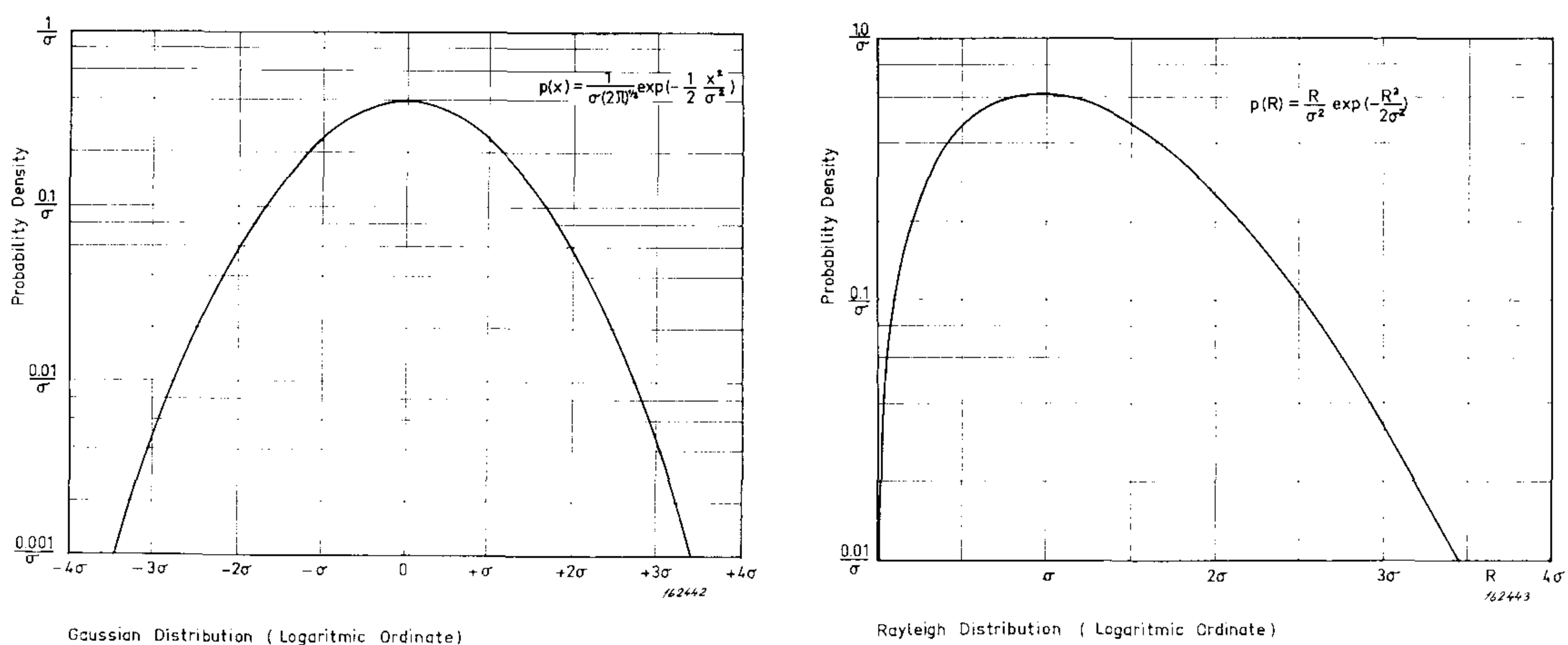

Fig. 9. The Gaussian and the Rayleigh distribution curves plotted with logarithmic ordinate.

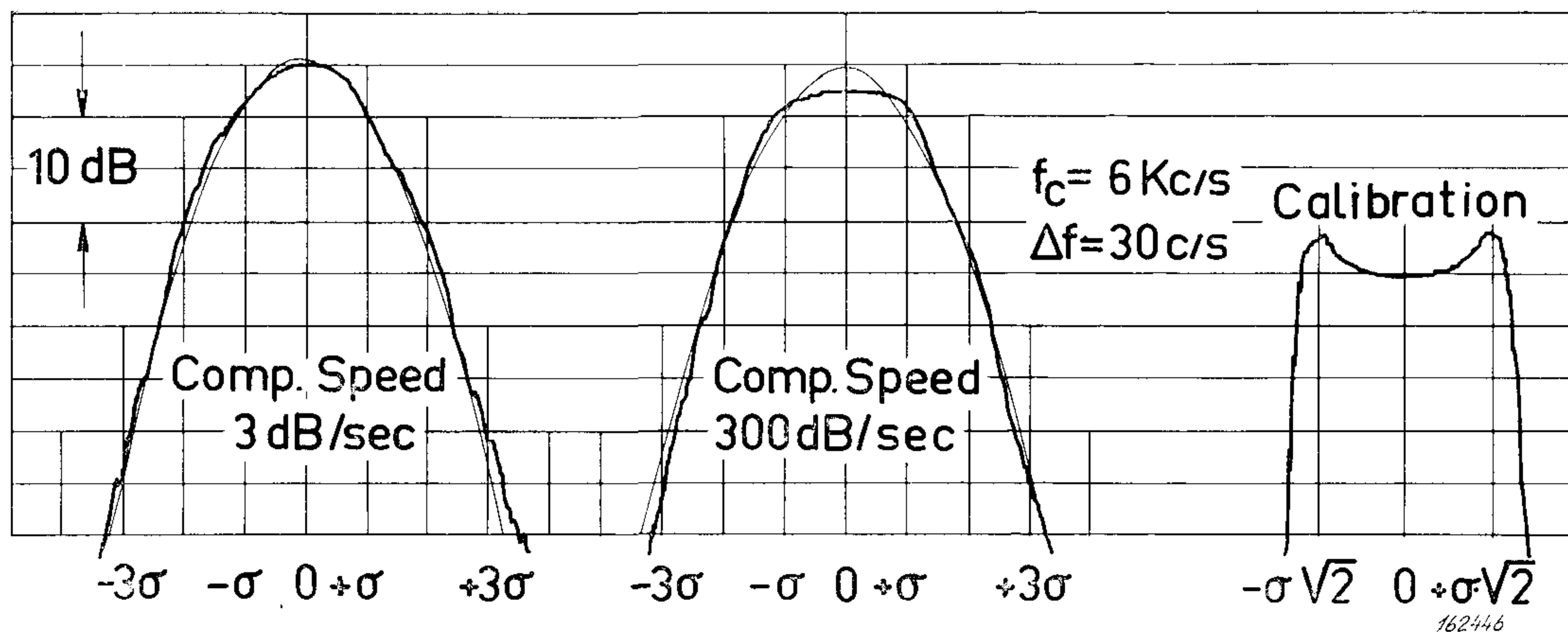

Fig. 10. Instantaneous voltage distribution curves for different compressor speeds.

For comparison the Rayleigh distribution curve has been plotted on each recording to the correct scale.

The probability density curves are recorded in logarithmic form to obtain a better accuracy at the high amplitudes than is possible with a linear scale. Fig. 9 shows the Rayleigh as well as the Gaussian distribution curves with logarithmic ordinate.

If the band noise signal to be analyzed is applied direct to the oscilloscope by-passing the rectifier, the probability density of the instantaneous voltage response can be recorded. An example is shown in Fig. 10. The center frequency, bandwidth and the compressor speeds being the same as in Fig. 8.

The feedback problems outlined here are mainly related to the design of the Narrow Band Noise Generator. In addition other problems will have to be considered by the user of the instrument. Besides choosing the correct compressor speed it must for instance be checked that amplifiers and transducers incorporated in the feedback loops are capable of handling signals with a crestfactor of at least 3.5.

It is expected that the Narrow Band Noise Generator will be a valuable supplement to existing Noise Generators and will find its applications where advantage can be taken of the constant absolute bandwidth, the exact defined magnitude distribution and the automatic output voltage regulation.

Selected References:

1. J. S. BENDAT: Principles and Applications of Random Noise Theory. John Wiley & Sons, Inc.
2. W. B. DAVENPORT: Random Signals and Noise.
3. GALT B. BOOTH: Sweep Random Vibration. M. B. Electronics, New Haven.
4. JENS T. BROCH: The Application and Generation of Audio Frequency Random Noise. B & K Technical Review No. 2-1961.
5. W. R. BENNETT: Electrical Noise. Mc Graw-Hill.

News from the Factory

Rain Cover UA 0056.

This accessory has been designed in order to allow permanent outdoor installation of the half-inch microphones, e.g. on airfields, even under extreme weather conditions. With a view of reducing the maintenance to a minimum, an electrostatic actuator is built in the rain cover, allowing remote controlled calibration and check of the installations to be made.

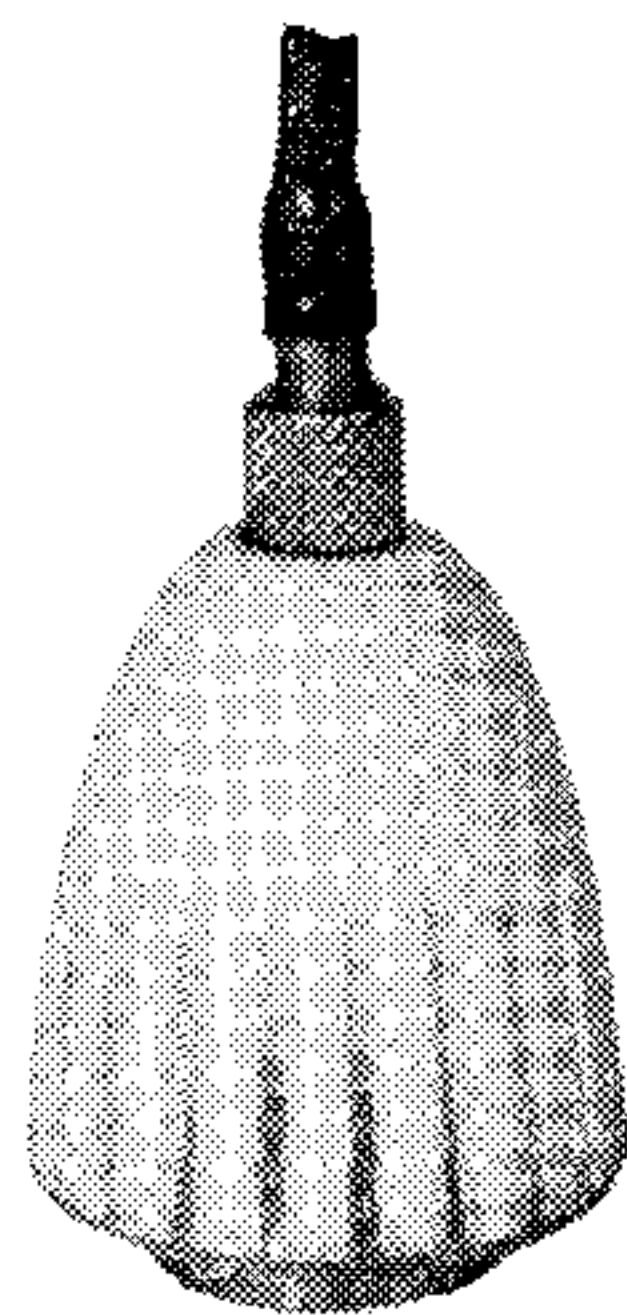

When the associated 4133 cartridge is ordered together with the UA 0056, the actuator is adjusted at the factory so as to obtain an equivalent S.P.L. of 90 ± 1 dB by injection of an AC voltage of 215 V (or 80 dB at 120 V).

NB: The microphone is only fully protected when the associated cathode follower Type 2614/15 is permanently heated.

Random Incidence Corrector UA 0055.

The one-inch microphone Type 4131 + 2612/13/30 or the Sound Level Meter Type 2203 may be made practically omnidirectional up to 10 kc/s by using the Random Incidence Corrector UA 0055. This specially shaped device, which

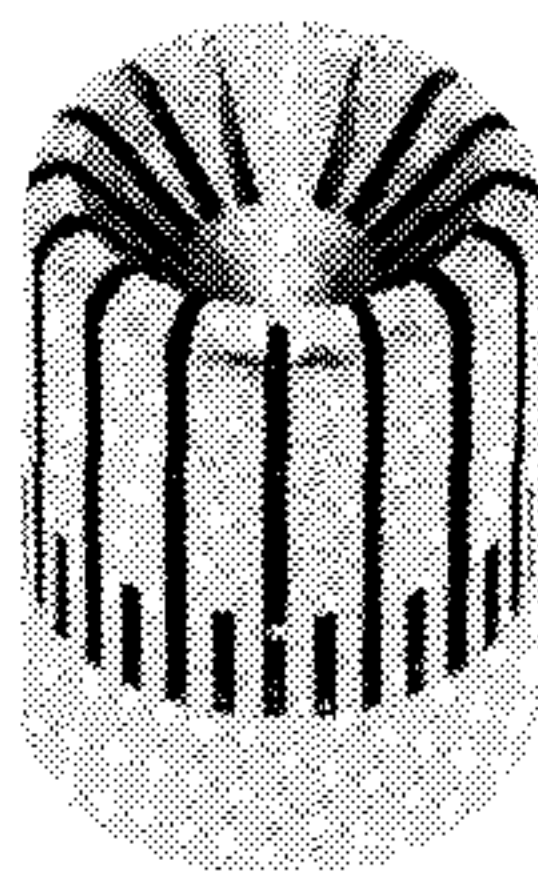

is designed to be mounted in place of the normal protecting grid, regroups the freefield response curves of the microphone at all incidences to within ± 3 dB of the random incidence response up to 10 kc/s, the linearity at 0° incidence being furthermore maintained up to 16 kc/s.

Battery-driven Cathode Follower Type 2630.

The Cathode Follower Type 2630 is designed according to the same principles as the Cathode Followers Types 2612—2615, but includes in its housing a transistorized power supply delivering the necessary polarization, plate and filament voltages from three small mercury cells. The external diameter of the housing is 23.77 mm (0.936") at input end for direct mounting of the

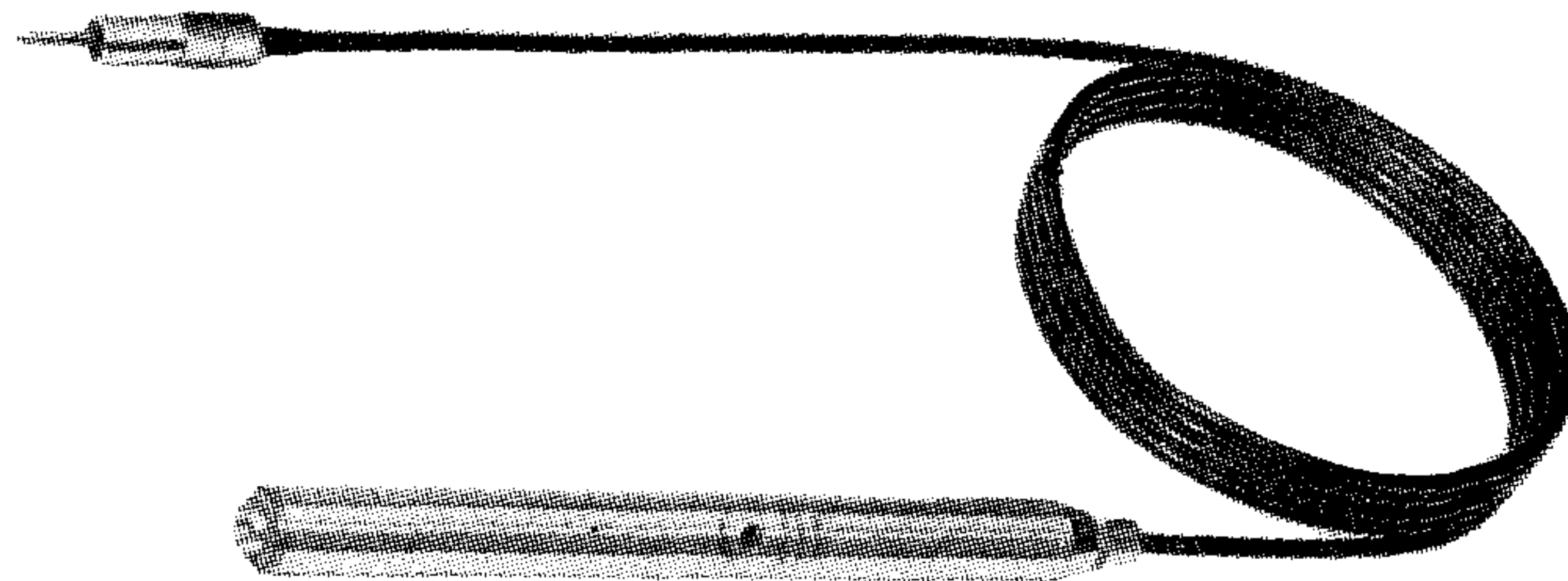

Microphone Cartridges Type 4131, and 25.4 mm (1") at battery end. The total length is 27 cm (11"). A small moving coil voltmeter is built-in for checking the batteries output voltage. The 2630 is equipped with a 3 m (10 ft) long cable at its output. It is delivered with 3 Mallory RM 1-R cells and an input adaptor for connection of accelerometers etc.

Psophometer Filter ZS 0301.

This filter has been designed for noise measurements on radio broadcasting audio systems, as required by C.C.I.F. (C.C.I.R., C.C.I.T.T.). Further details can be found in the C.C.I.F. "Green-book", pp. 126 etc., as well as in the German Standard DIN 45405.

The maximum allowable input voltage is 1 V approx. (max. crest-factor 5) and the input impedance is somewhat frequency dependent (2000—600 Ω). It should be connected to a low generator impedance (10 Ω) and the output should be loaded by 146 k Ω . These matching conditions are automatically



fulfilled when the filter is used as "External Filter" in combination with the Amplifier Type 2604. However, when used together with the Amplifier Type 2603 or the Analyzers Types 2107 or 2112 a load resistance of 162 k Ω should be connected in parallel with the filter output.

When using other than the B & K AO 0013 or AO 0014 cables for connection of the filter to one of the above mentioned amplifiers or analyzers it should be noted that the cable capacity should be lower than 250 pF to keep the filter characteristics well within the tolerance permitted in the various standards.

Brüel & Kjær

ADR.: BRÜEL & KJÆR
NÆRUM - DENMARK

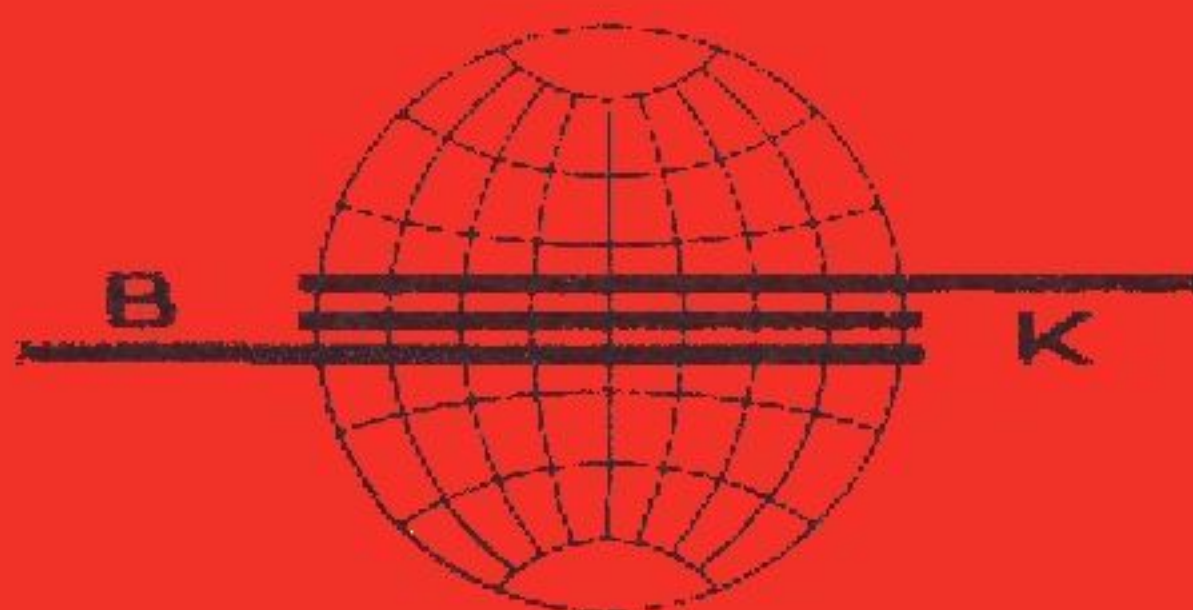

TELEX 5316

TELEPHONE: 800500
BRUKJA, Copenhagen